

RTUE20 INA

Ball bearing units

TYPE: Housing units, Take-up housing units, Cast iron housing, Radial insert ball bearing with eccentric locking collar, Type RTUE (INA)

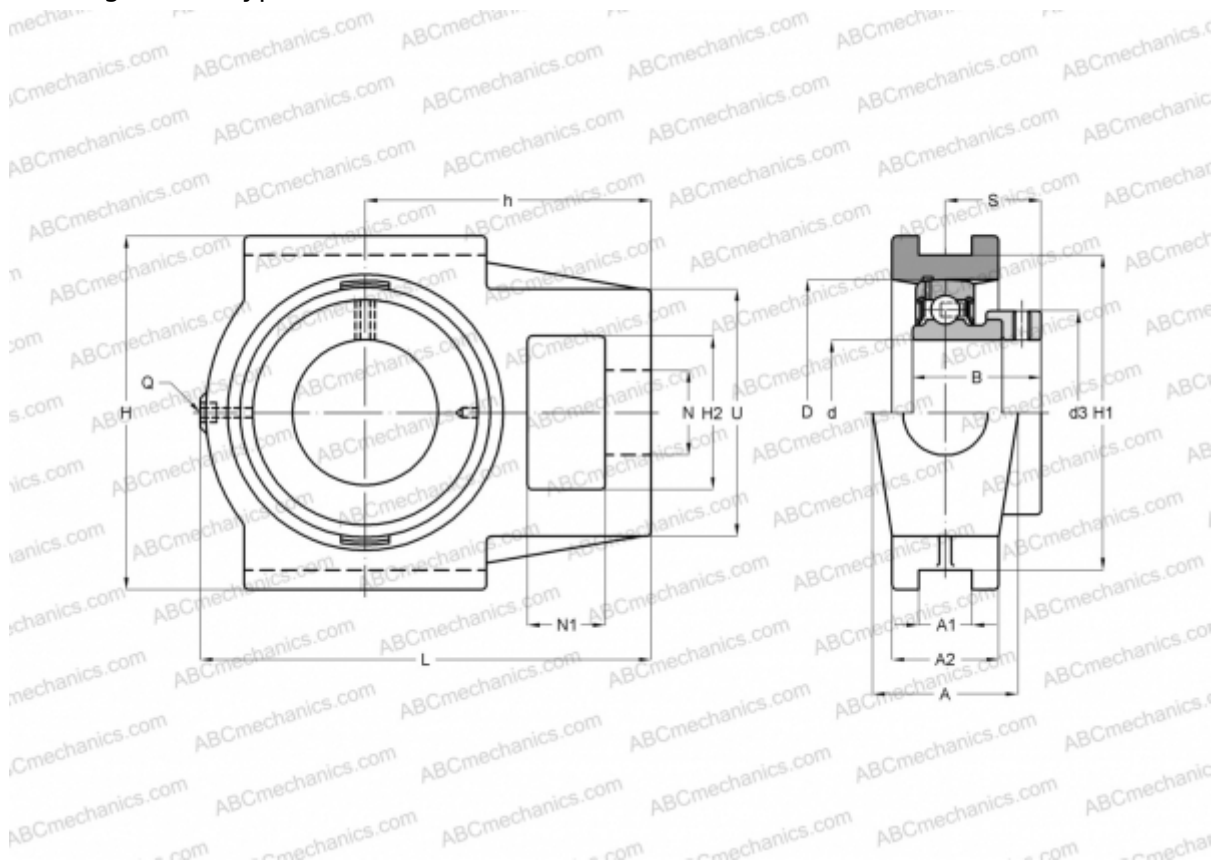

Technical specification

DIMENSIONS, MM

d	20,000
D	47,000
B	43,700
L	94,500
H	90,000
A	37,000
H2	32,000
A1	12,000
A2	25,000
H1	76,000
N	19,000
N1	18,000
S	26,600
d3	33,000
U	51,000

DIMENSIONS, MM

h	60,000
Q	Rp1/8

WEIGHT, KG

Bearing	0,900
Housing	GE20-KRR-B
	GG.TUE04

MANUFACTURER

[INA](#)

CALCULATION DATA

Basic dynamic load rating, C	12,800 kN
Basic static load rating, Co	6,600 kN