

## RTUE25 INA

Ball bearing units

TYPE: Housing units, Take-up housing units, Cast iron housing, Radial insert ball bearing with eccentric locking collar, Type RTUE (INA)

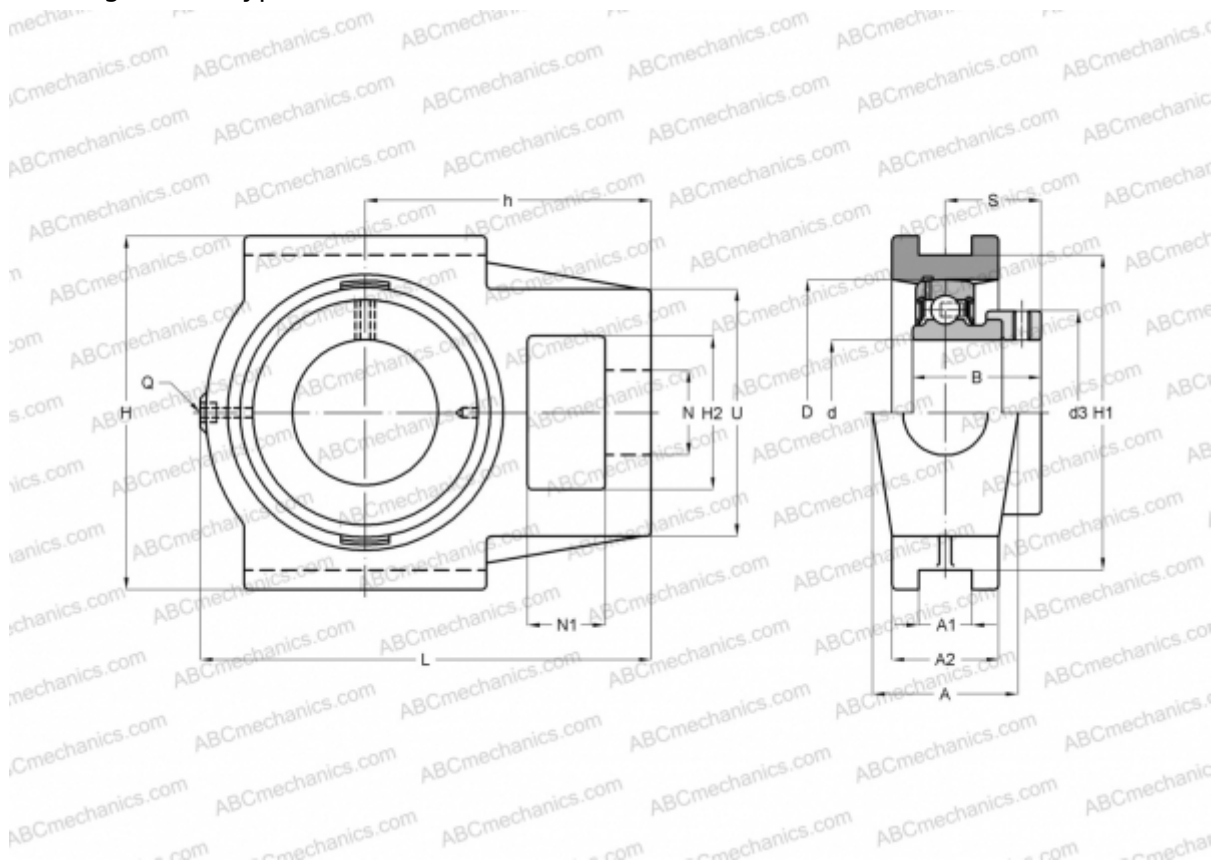

### Technical specification

#### DIMENSIONS, MM

d	25,000
D	52,000
B	44,500
L	98,500
H	90,000
A	37,000
H2	32,000
A1	12,000
A2	25,000
H1	76,000
N	19,000
N1	18,000
S	27,000
d3	37,500
U	51,000

#### DIMENSIONS, MM

h	62,000
Q	Rp1/8

#### WEIGHT, KG

Bearing	0,910
Housing	GE25-KRR-B
	GG.TUE05

#### MANUFACTURER

[INA](#)

#### CALCULATION DATA

Basic dynamic load rating, C	14,000 kN
Basic static load rating, Co	7,800 kN