

## RTUE80 INA

Ball bearing units

TYPE: Housing units, Take-up housing units, Cast iron housing, Radial insert ball bearing with eccentric locking collar, Type RTUE (INA)

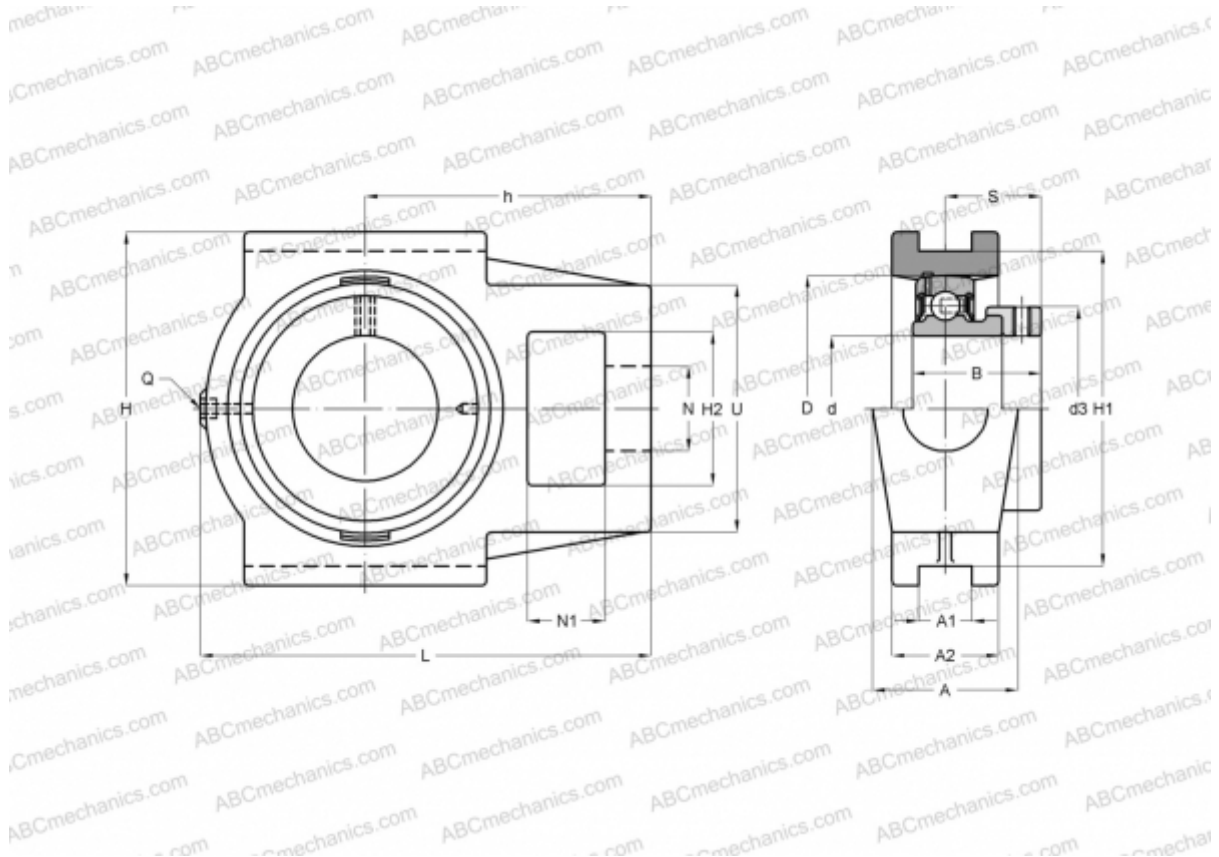

### Technical specification

#### DIMENSIONS, MM

d	80,000
D	140,000
B	70,700
L	230,000
H	184,000
A	70,000
H2	70,000
A1	28,000
A2	50,000
H1	165,000
N	41,000
N1	35,000
S	47,600
d3	108,000
U	110,000

#### DIMENSIONS, MM

h	140,000
Q	Rp1/8

#### WEIGHT, KG

Bearing	8,400
Housing	GE80-KRR-B
	GG.TUE16

#### MANUFACTURER

[INA](#)

#### CALCULATION DATA

Basic dynamic load rating, C	72,000 kN
Basic static load rating, Co	54,000 kN