

RTUE90 INA

Ball bearing units

TYPE: Housing units, Take-up housing units, Cast iron housing, Radial insert ball bearing with eccentric locking collar, Type RTUE (INA)

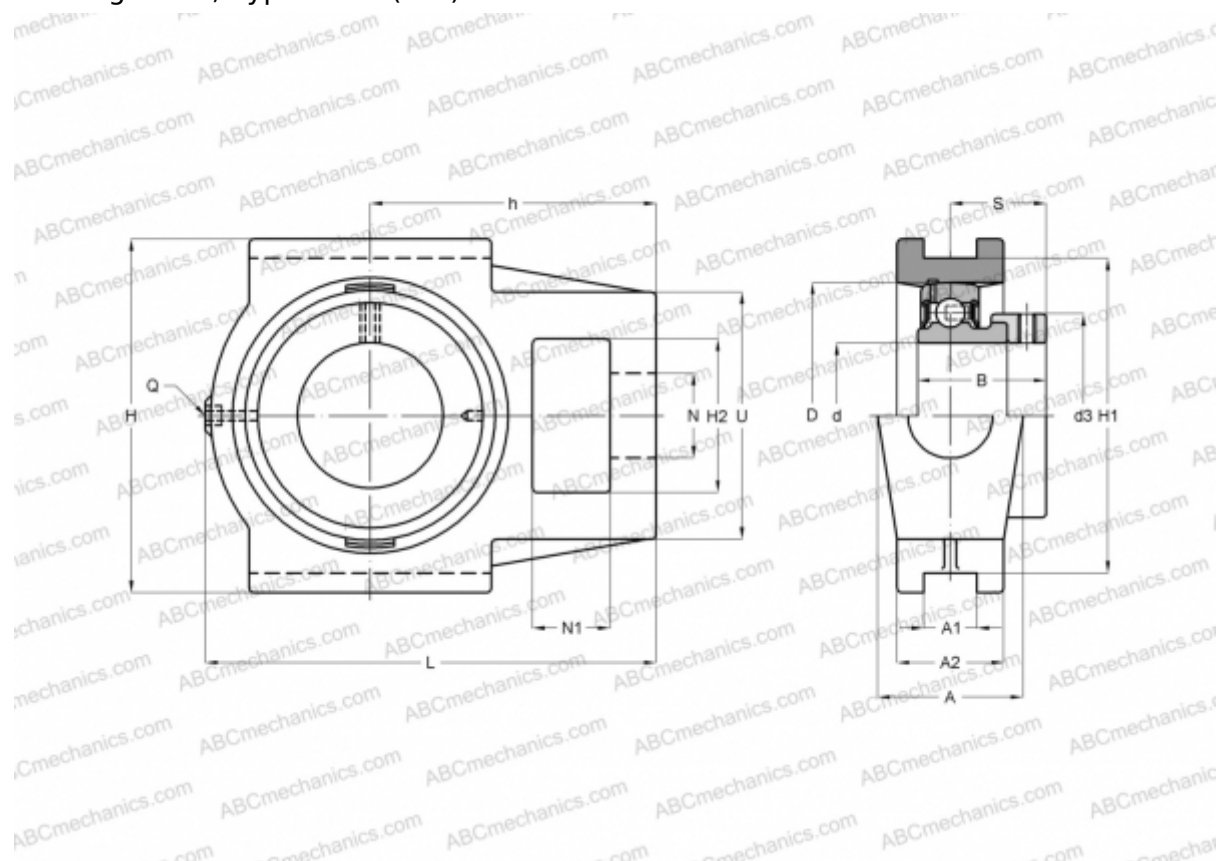

Technical specification

DIMENSIONS, MM

d	90,000
D	160,000
B	69,500
L	275,000
H	215,000
A	80,000
H2	80,000
A1	28,000
A2	55,000
H1	190,000
N	47,000
N1	40,000
S	46,500
d3	118,000
U	130,000

DIMENSIONS, MM

h	170,000
Q	Rp1/8

WEIGHT, KG

Bearing	11,870
Housing	GE90-KRR-B
	GG.TUE18

MANUFACTURER

[INA](#)

CALCULATION DATA

Basic dynamic load rating, C	96,000 kN
Basic static load rating, Co	72,000 kN