

TTUE30 INA

Ball bearing units

TYPE: Housing units, Take-up housing units, Cast iron housing, Radial insert ball bearing with eccentric locking collar, Type TTUE (INA)

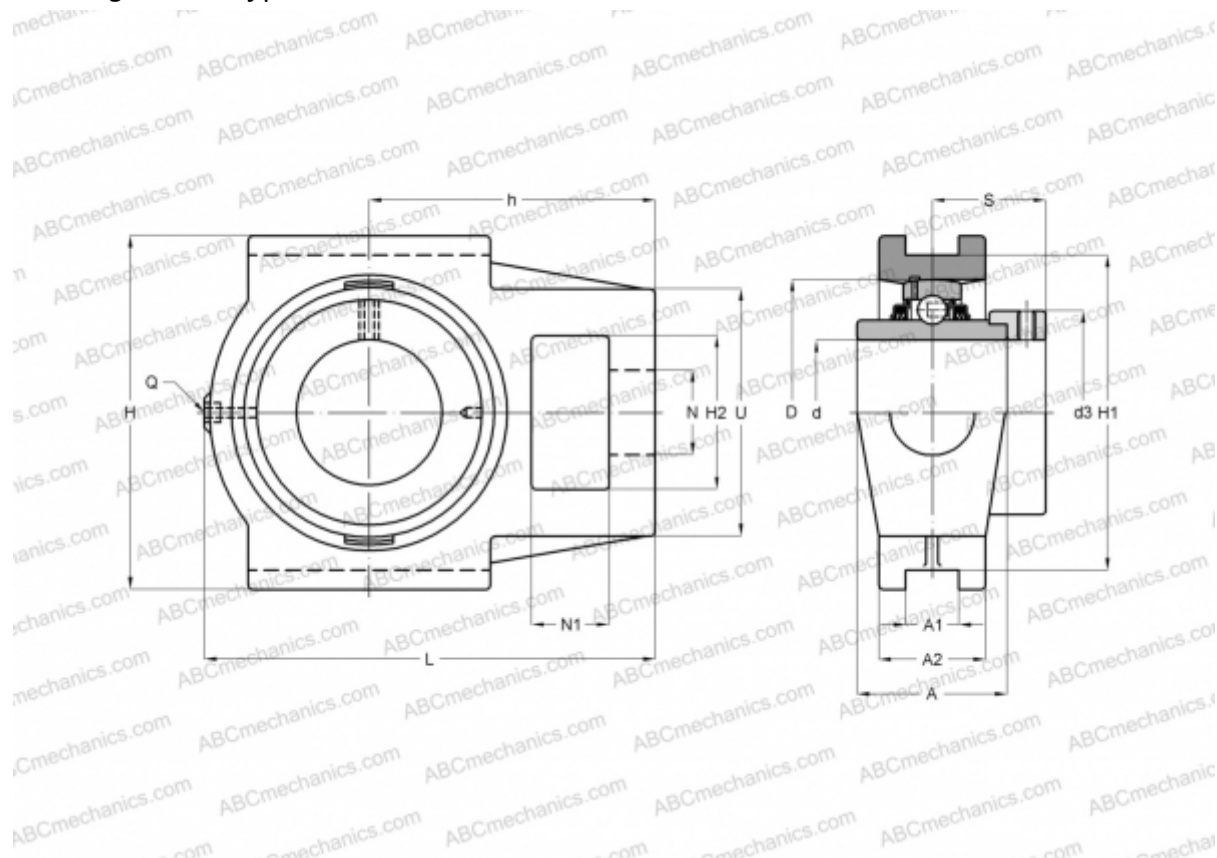

Technical specification

DIMENSIONS, MM

d	30,000
D	62,000
B	48,500
L	114,500
H	102,000
A	37,000
H2	36,500
A1	12,000
A2	25,000
H1	89,000
N	22,000
N1	18,000
S	30,200
d3	44,000
U	56,000

DIMENSIONS, MM

h	70,000
Q	Rp1/8

WEIGHT, KG

Bearing	1,250
Housing	GE30-KTT-B
	GG.TUE06

MANUFACTURER

[INA](#)

CALCULATION DATA

Basic dynamic load rating, C	19,500 kN
Basic static load rating, Co	11,300 kN