

TTUE45 INA

Ball bearing units

TYPE: Housing units, Take-up housing units, Cast iron housing, Radial insert ball bearing with eccentric locking collar, Type TTUE (INA)

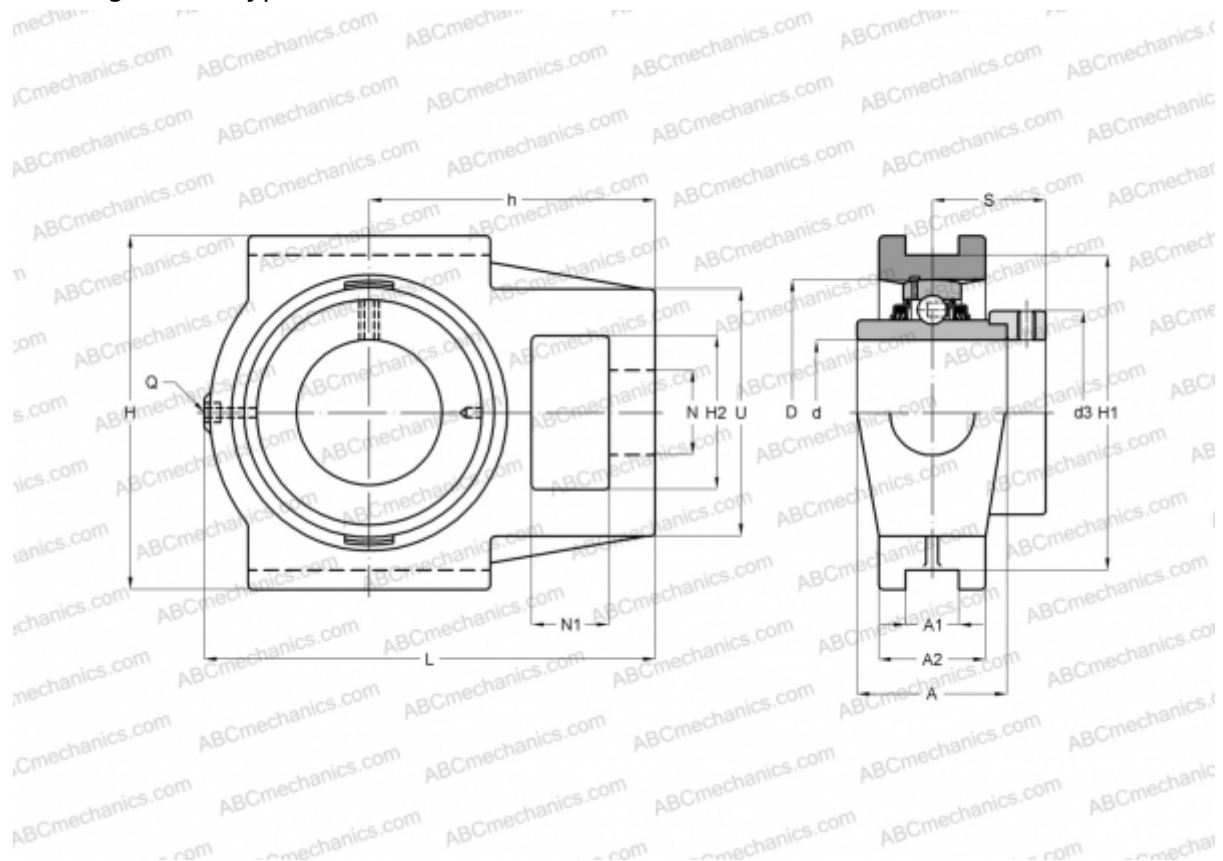

Technical specification

DIMENSIONS, MM

d	45,000
D	85,000
B	56,500
L	141,000
H	115,000
A	50,000
H2	49,000
A1	16,000
A2	35,000
H1	102,000
N	29,000
N1	20,000
S	35,100
d3	63,000
U	82,000

DIMENSIONS, MM

h	88,000
Q	Rp1/8

WEIGHT, KG

Bearing	2,450
Housing	GE45-KTT-B
	GG.TUE09

MANUFACTURER

[INA](#)

CALCULATION DATA

Basic dynamic load rating, C	32,500 kN
Basic static load rating, Co	20,400 kN