

## TTUE50 INA

Ball bearing units

TYPE: Housing units, Take-up housing units, Cast iron housing, Radial insert ball bearing with eccentric locking collar, Type TTUE (INA)

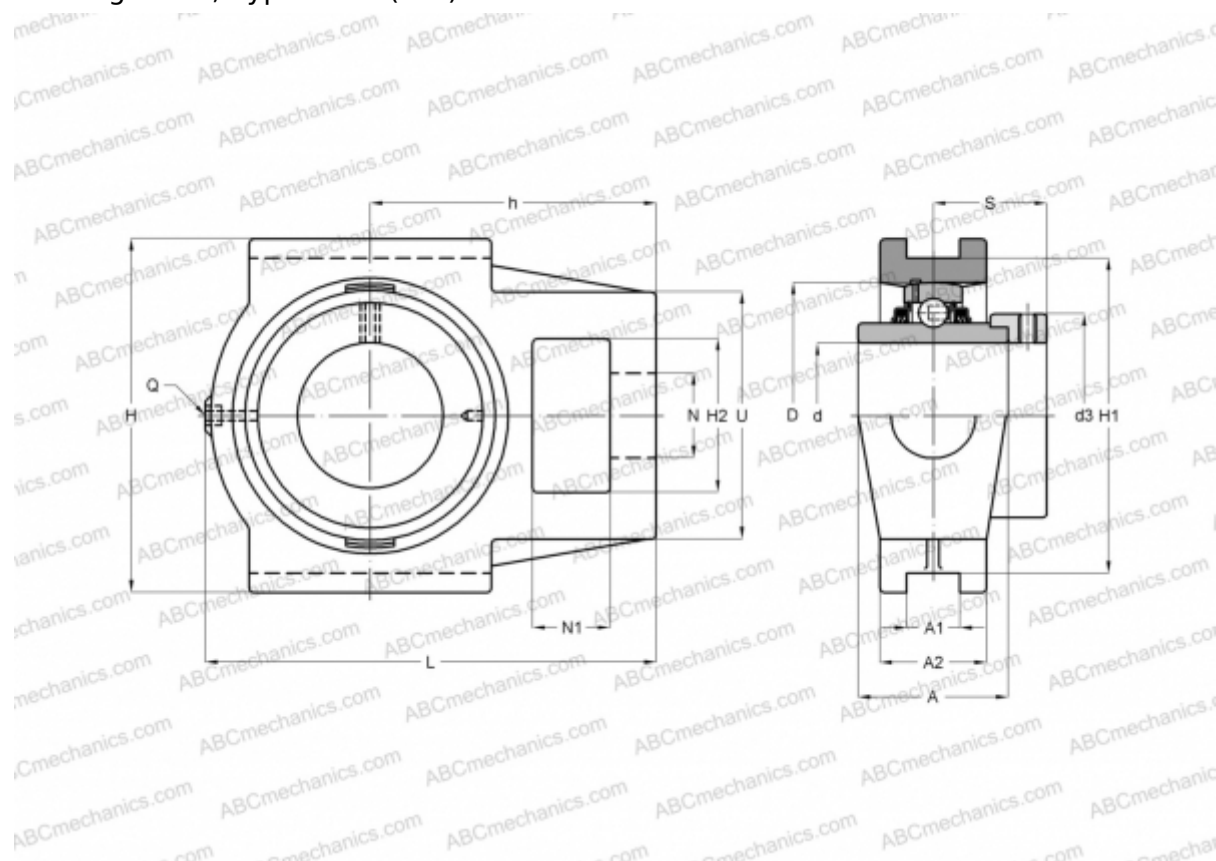

### Technical specification

#### DIMENSIONS, MM

d	50,000
D	90,000
B	62,800
L	148,000
H	115,000
A	50,000
H2	49,000
A1	16,000
A2	35,000
H1	102,000
N	29,000
N1	20,000
S	38,200
d3	69,000
U	83,000

#### DIMENSIONS, MM

h	90,000
Q	Rp1/8

#### WEIGHT, KG

Bearing	2,560
Housing	GE50-KTT-B
	GG.TUE10

#### MANUFACTURER

[INA](#)

#### CALCULATION DATA

Basic dynamic load rating, C	35,000 kN
Basic static load rating, Co	23,200 kN