

RHE25 INA

Ball bearing units

TYPE: Housing units, Take-up housing units, Cast iron housing, Radial insert ball bearing with eccentric locking collar, Type RHE (INA)

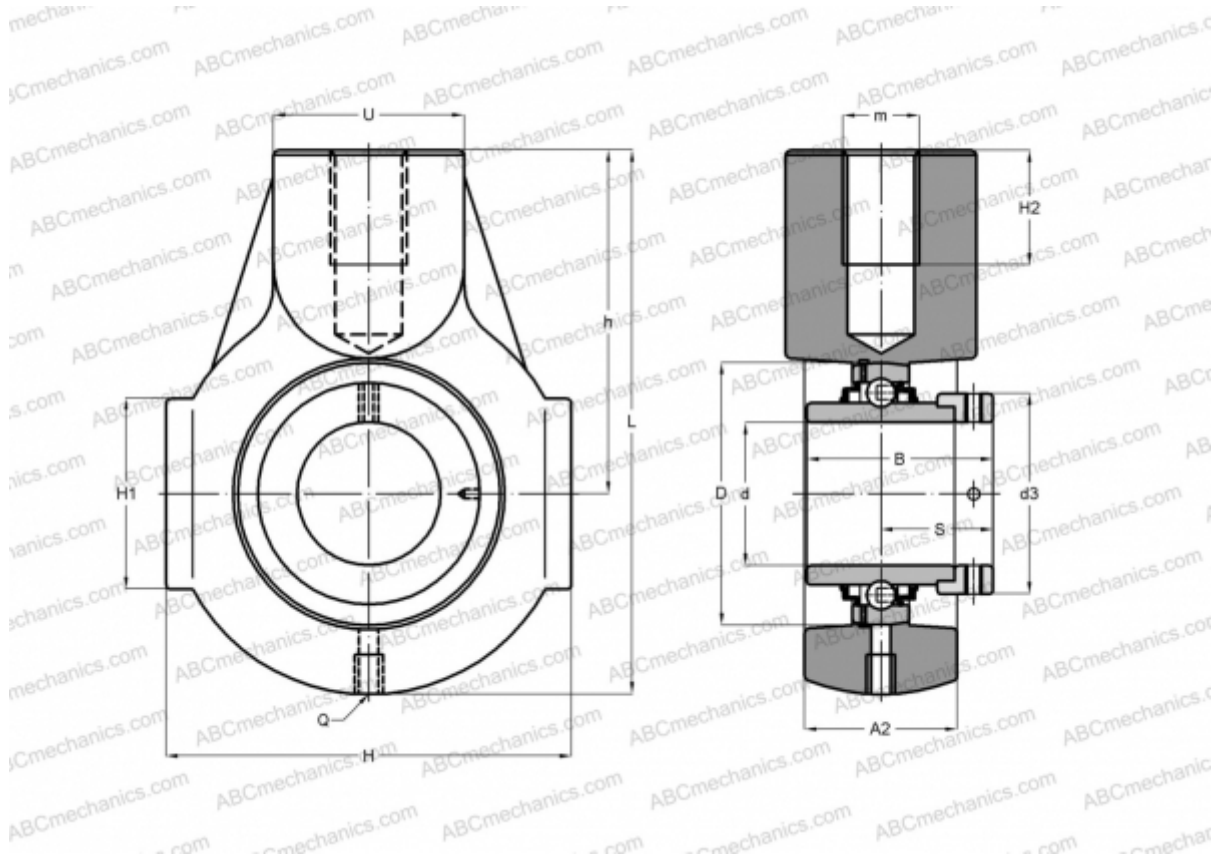

Technical specification

DIMENSIONS, MM

d	25,000
D	52,000
B	44,500
L	99,000
H	70,000
H2	22,000
A2	28,000
H1	38,000
S	27,000
d3	37,500
U	35,000
h	64,000
Q	Rp1/8

Bearing	GE25-KRR-B
Housing	GG.HE05

MANUFACTURER

[INA](#)

CALCULATION DATA

Basic dynamic load rating, C	14,000 kN
Basic static load rating, Co	7,800 kN

WEIGHT, KG 0,770