

RHE30 INA

Ball bearing units

TYPE: Housing units, Take-up housing units, Cast iron housing, Radial insert ball bearing with eccentric locking collar, Type RHE (INA)

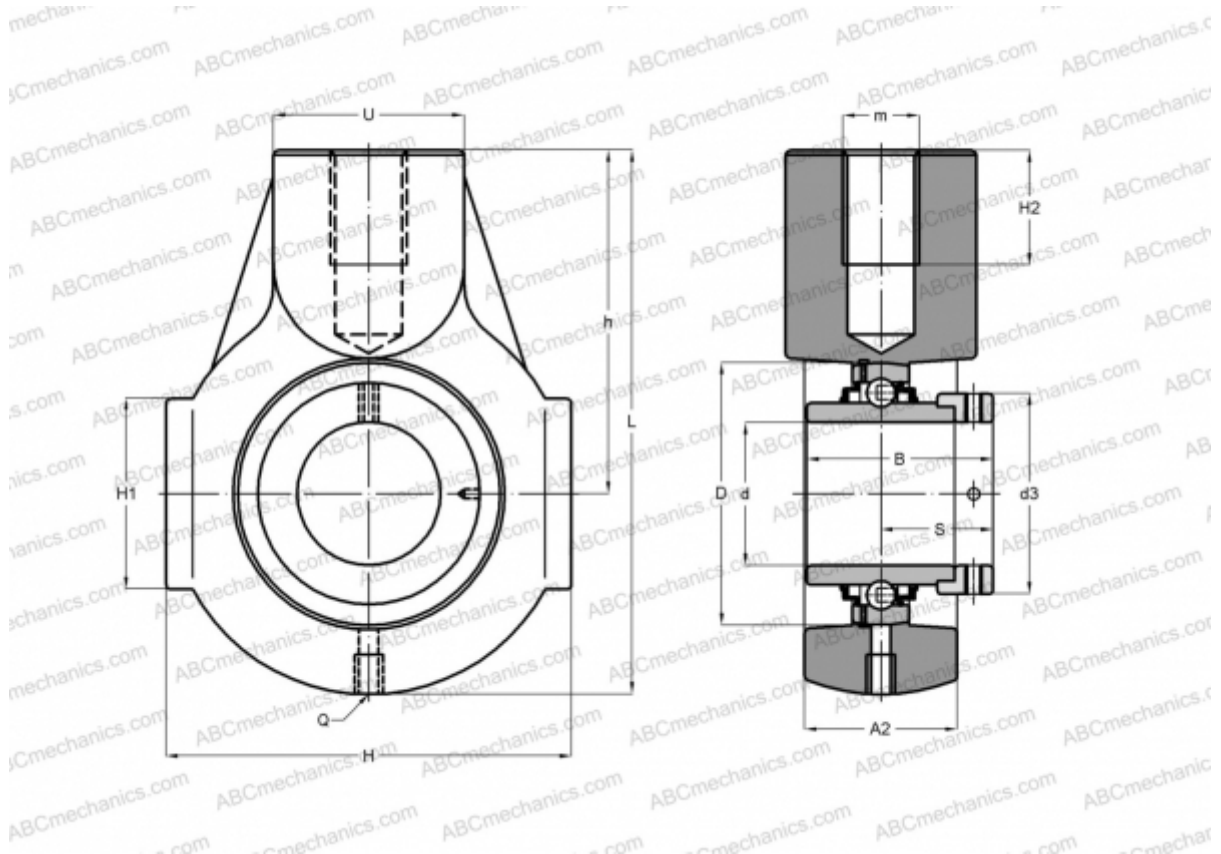

Technical specification

DIMENSIONS, MM

d	30,000
D	62,000
B	48,500
L	114,000
H	85,000
H2	24,000
A2	32,000
H1	40,000
S	30,200
d3	44,000
U	40,000
h	72,000
Q	Rp1/8

Bearing	GE30-KRR-B
Housing	GG.HE06

MANUFACTURER

[INA](#)

CALCULATION DATA

Basic dynamic load rating, C	19,500 kN
Basic static load rating, Co	11,300 kN

WEIGHT, KG 1,160