

RHE45 INA

Ball bearing units

TYPE: Housing units, Take-up housing units, Cast iron housing, Radial insert ball bearing with eccentric locking collar, Type RHE (INA)

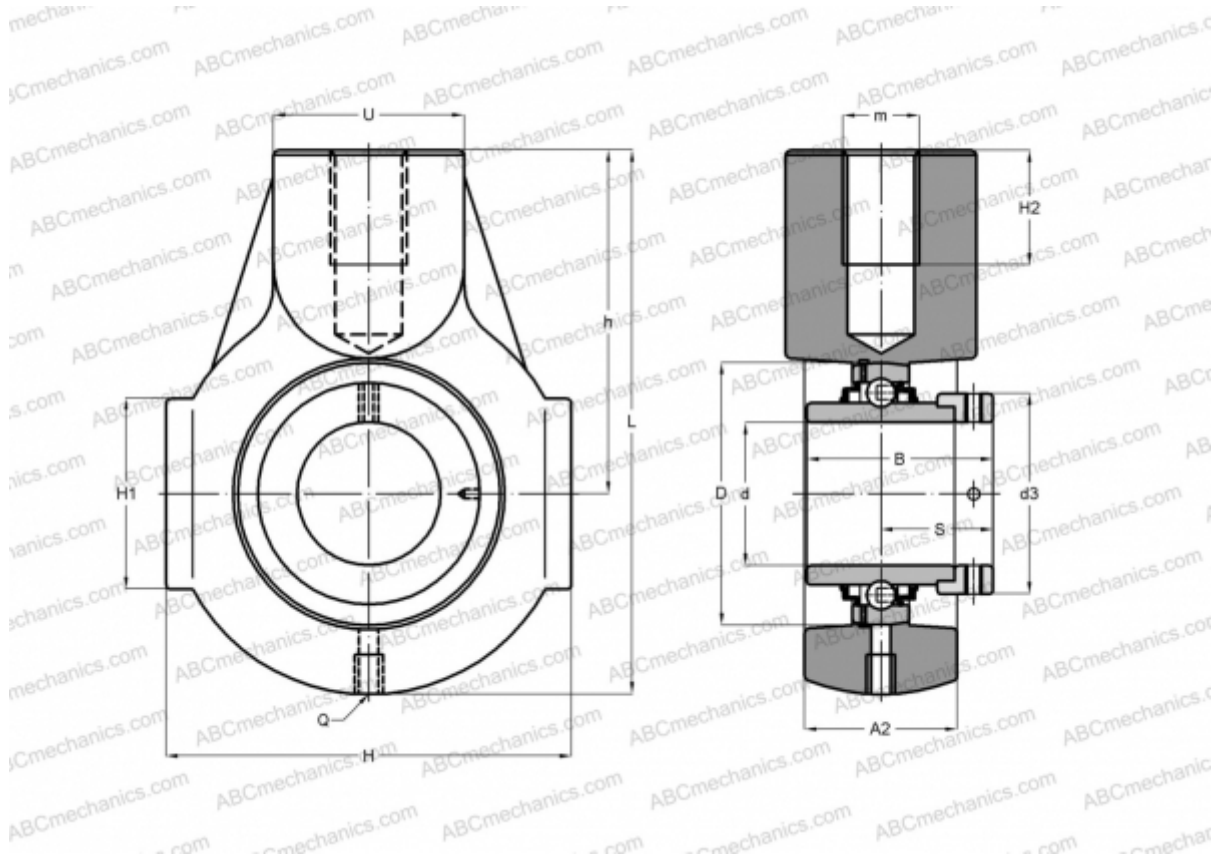

Technical specification

DIMENSIONS, MM

d	45,000
D	85,000
B	56,500
L	145,000
H	110,000
H2	24,000
A2	40,000
H1	45,000
S	35,100
d3	63,000
U	40,000
h	90,000
Q	Rp1/8

Bearing	GE45-KRR-B
Housing	GG.HE09

MANUFACTURER

[INA](#)

CALCULATION DATA

Basic dynamic load rating, C	32,500 kN
Basic static load rating, Co	20,400 kN

WEIGHT, KG 2,010