

THE50 INA

Ball bearing units

TYPE: Housing units, Take-up housing units, Cast iron housing, Radial insert ball bearing with eccentric locking collar, Type THE (INA)

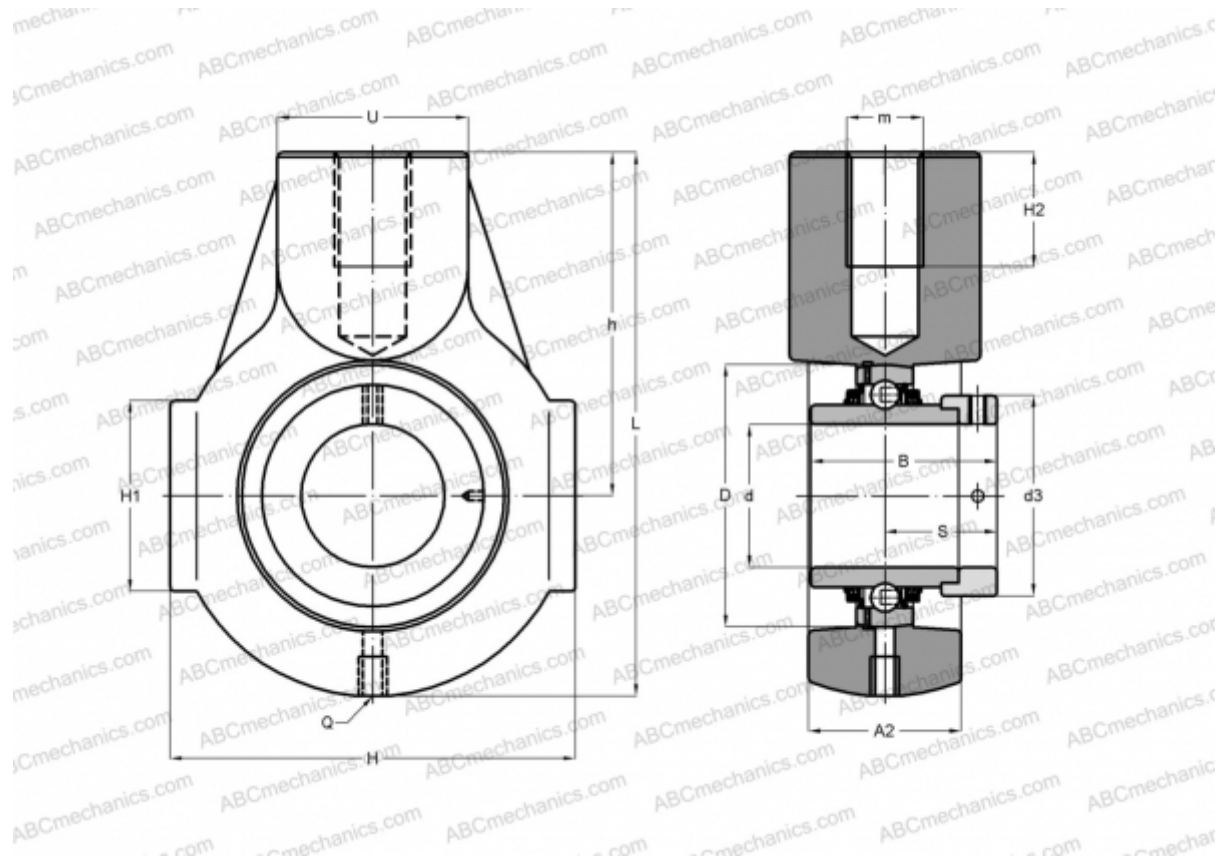

Technical specification

DIMENSIONS, MM

d	50,000
D	90,000
B	62,800
L	145,000
H	110,000
H2	24,000
A2	40,000
H1	46,000
S	38,200
d3	69,000
U	40,000
h	90,000
Q	Rp1/8

Bearing	GE50-KTT-B
Housing	GG.HE10

MANUFACTURER

[INA](#)

CALCULATION DATA

Basic dynamic load rating, C	35,000 kN
Basic static load rating, Co	23,200 kN

WEIGHT, KG 2,080