

PTUEY20 INA

Ball bearing units

TYPE: Housing units, Take-up housing units, Cast iron housing, Radial insert ball bearing with grub screws in inner ring, Type PTUEY (INA)

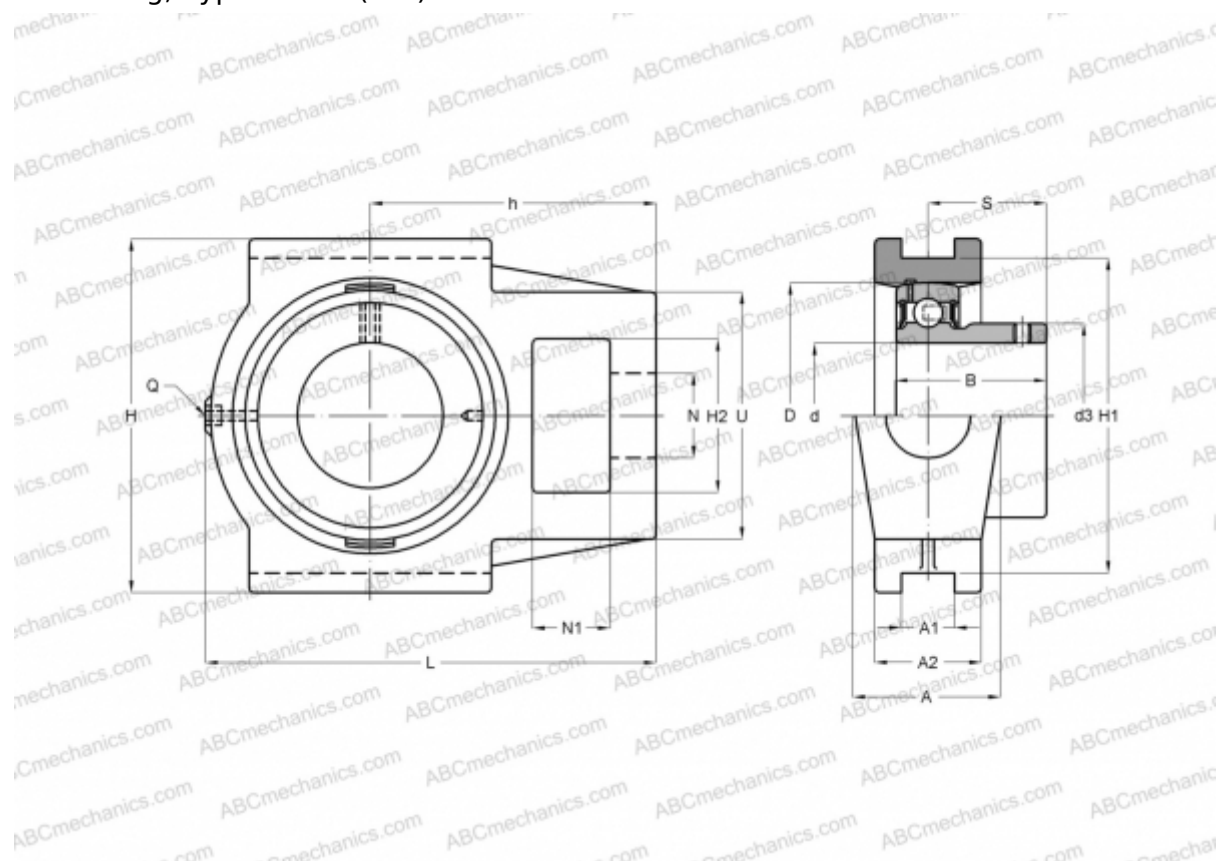

Technical specification

DIMENSIONS, MM

d	20,000
D	47,000
B	25,000
L	94,500
H	90,000
A	37,000
H2	32,000
A1	12,000
A2	25,000
H1	76,000
N	19,000
N1	18,000
S	18,000
U	51,000
h	60,000

DIMENSIONS, MM

Q	Rp1/8
---	-------

WEIGHT, KG

0,800	
Bearing	GAY20-NPP-B
Housing	GG.TUE04

MANUFACTURER

[INA](#)

CALCULATION DATA

Basic dynamic load rating, C	12,800 kN
Basic static load rating, Co	6,600 kN