

PTUEY25 INA

Ball bearing units

TYPE: Housing units, Take-up housing units, Cast iron housing, Radial insert ball bearing with grub screws in inner ring, Type PTUEY (INA)

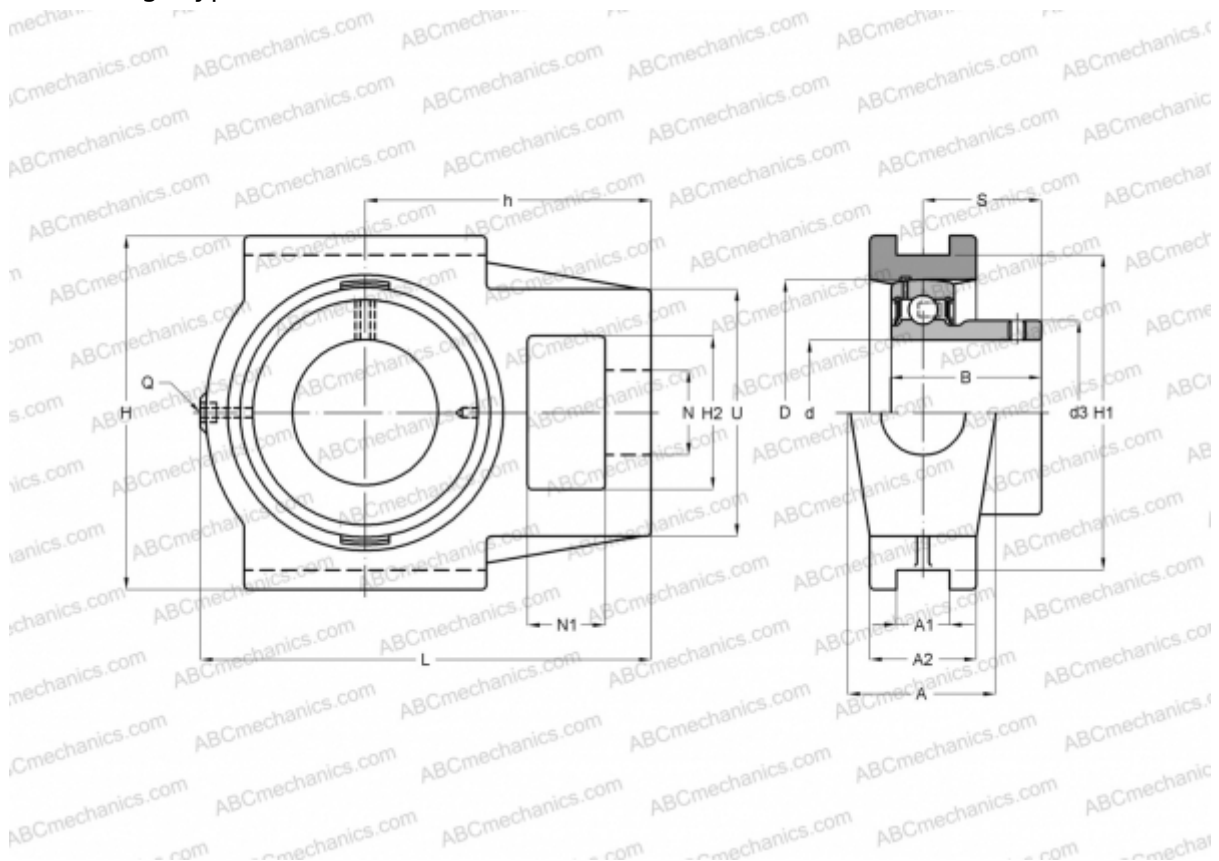

Technical specification

DIMENSIONS, MM

d	25,000
D	52,000
B	27,000
L	98,500
H	90,000
A	37,000
H2	32,000
A1	12,000
A2	25,000
H1	76,000
N	19,000
N1	18,000
S	19,500
U	51,000
h	62,000

DIMENSIONS, MM

Q	Rp1/8
---	-------

WEIGHT, KG

	0,820
Bearing	GAY25-NPP-B
Housing	GG.TUE05

MANUFACTURER

[INA](#)

CALCULATION DATA

Basic dynamic load rating, C	14,000 kN
Basic static load rating, Co	7,800 kN