

PTUEY50 INA

Ball bearing units

TYPE: Housing units, Take-up housing units, Cast iron housing, Radial insert ball bearing with grub screws in inner ring, Type PTUEY (INA)

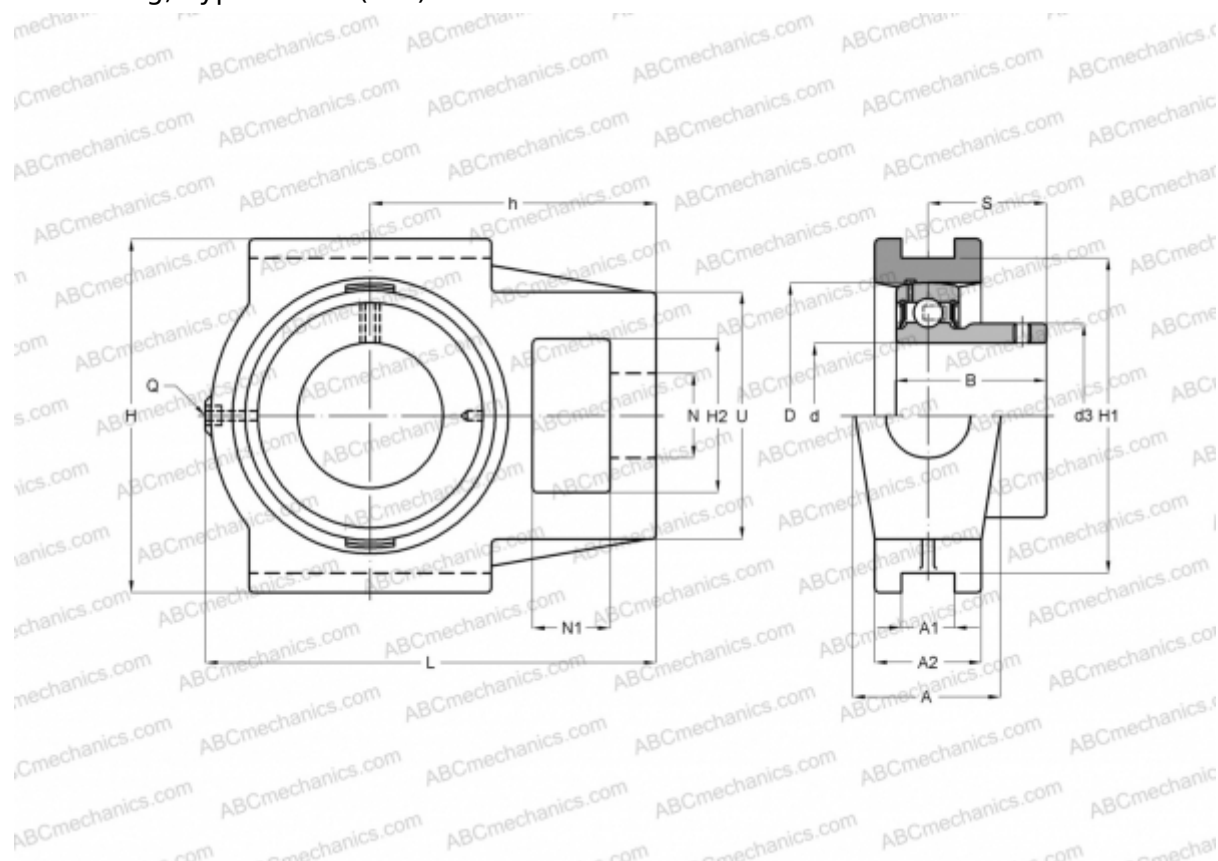

Technical specification

DIMENSIONS, MM

d	50,000
D	90,000
B	43,000
L	148,000
H	115,000
A	50,000
H2	49,000
A1	16,000
A2	35,000
H1	102,000
N	29,000
N1	20,000
S	32,000
U	83,000
h	90,000

DIMENSIONS, MM

Q	Rp1/8
---	-------

WEIGHT, KG

Bearing	GAY50-NPP-B
Housing	GG.TUE10

MANUFACTURER

[INA](#)

CALCULATION DATA

Basic dynamic load rating, C	35,000 kN
Basic static load rating, Co	23,200 kN