

RTUEY75 INA

Ball bearing units

TYPE: Housing units, Take-up housing units, Cast iron housing, Radial insert ball bearing with grub screws in inner ring, Type RTUEY (INA)

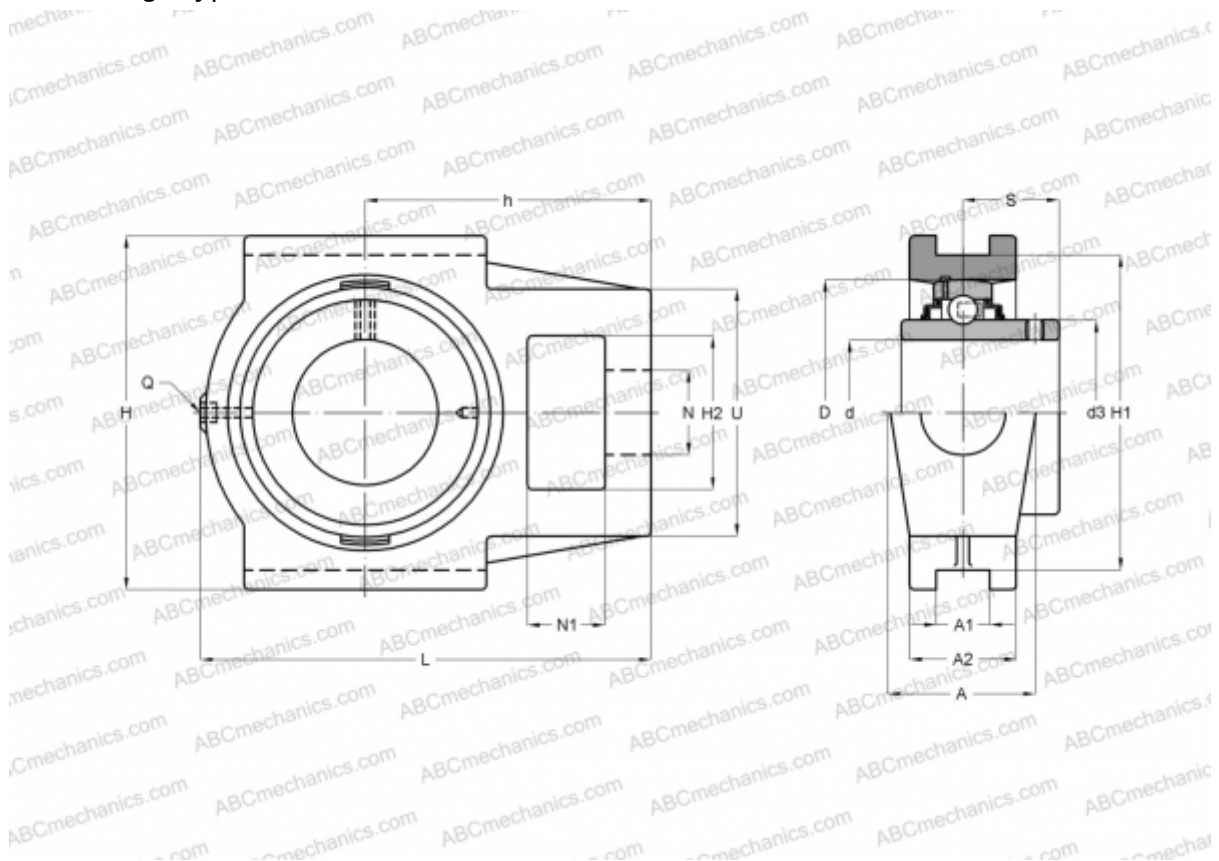

Technical specification

DIMENSIONS, MM

d	75,000
D	130,000
B	77,800
L	214,000
H	166,000
A	70,000
H2	70,000
A1	25,000
A2	50,000
H1	151,000
N	41,000
N1	35,000
S	44,500
U	110,000
h	135,000

DIMENSIONS, MM

Q	Rp1/8
---	-------

WEIGHT, KG

Bearing	6,380
Housing	GYE75-KRR-B
	GG.TUE15

MANUFACTURER

[INA](#)

CALCULATION DATA

Basic dynamic load rating, C	62,000 kN
Basic static load rating, Co	44,500 kN