

PHEY20 INA

Ball bearing units

TYPE: Housing units, Take-up housing units, Cast iron housing, Radial insert ball bearing with grub screws in inner ring, Type PHEY (INA)

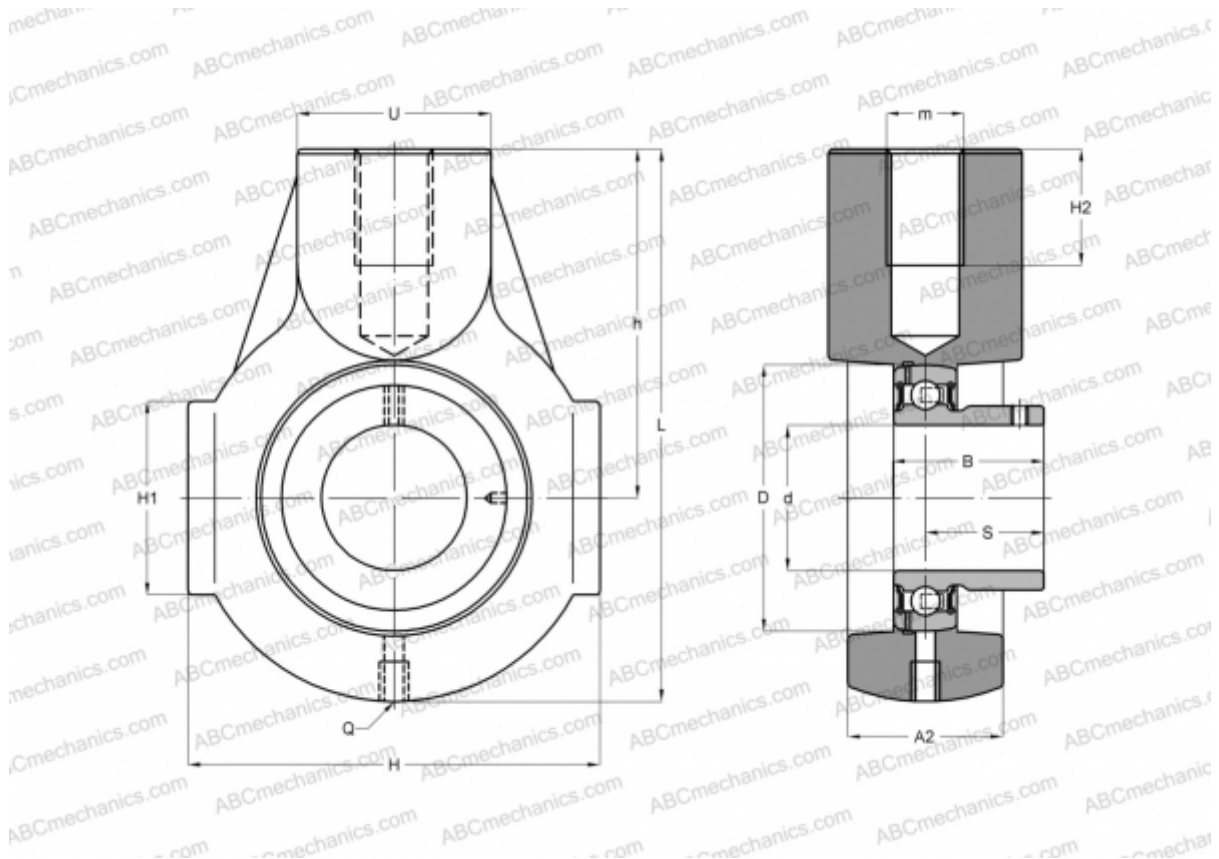

Technical specification

DIMENSIONS, MM

d	20,000
D	47,000
B	25,000
L	91,000
H	65,000
H2	21,000
A2	25,000
H1	38,000
S	18,000
U	30,000
h	58,000
Q	Rp1/8

WEIGHT, KG 0,510

Bearing	GAY20-NPP-B
Housing	GG.HE04

MANUFACTURER

[INA](#)

CALCULATION DATA

Basic dynamic load rating, C	12,800 kN
Basic static load rating, Co	6,600 kN