

## PHEY25 INA

Ball bearing units

TYPE: Housing units, Take-up housing units, Cast iron housing, Radial insert ball bearing with grub screws in inner ring, Type PHEY (INA)

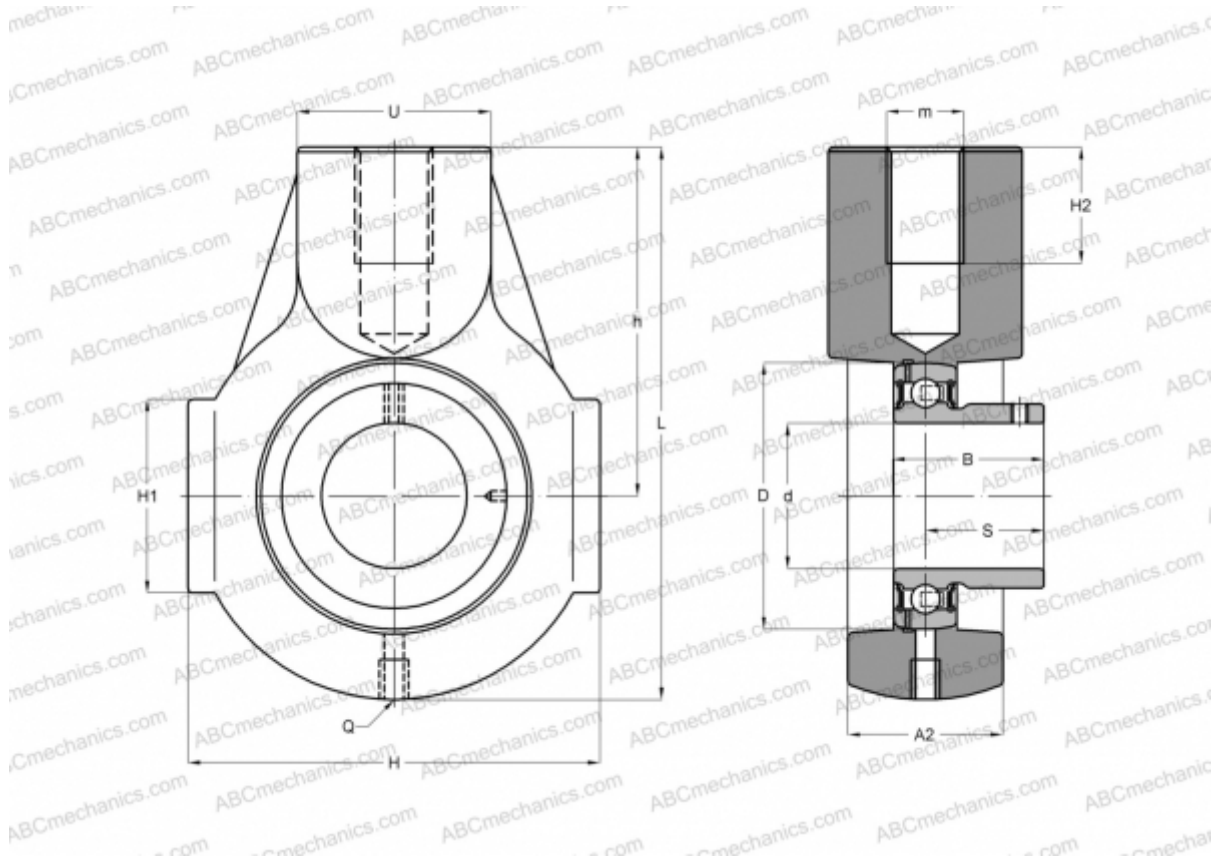

### Technical specification

#### DIMENSIONS, MM

d	25,000
D	52,000
B	27,000
L	99,000
H	70,000
H2	22,000
A2	28,000
H1	38,000
S	19,500
U	35,000
h	64,000
Q	Rp1/8

**WEIGHT, KG** 0,680

Bearing	GAY25-NPP-B
Housing	GG.HE05

#### MANUFACTURER

[INA](#)

#### CALCULATION DATA

Basic dynamic load rating, C	14,000 kN
Basic static load rating, Co	7,800 kN