

PHUSE35 INA

Ball bearing units

TYPE: Housing units, Take-up housing units, Cast iron and sheet steel housing, Radial insert ball bearing with eccentric locking collar, Type PHUSE (INA)

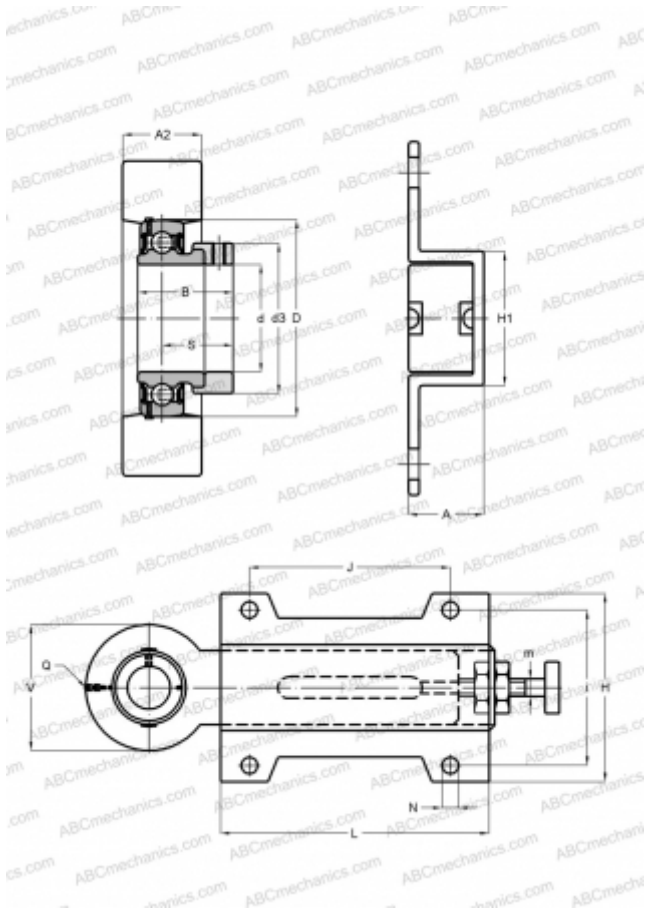

Technical specification

DIMENSIONS, MM

d	35,000
D	72,000
B	39,000
L	187,000
H	103,000
A	28,000
J	140,000
A2	22,000
H1	52,000
N	11,500
S	29,400
d3	51,000
V	98,000
I	80,000
Q	Rp1/8

WEIGHT, KG

Bearing	GRAE35-NPP-B
Housing	HUE07 / HUSE07

MANUFACTURER

[INA](#)

CALCULATION DATA

Basic dynamic load rating, C	25,500 kN
Basic static load rating, Co	15,300 kN