

UCP202 SNR

Ball bearing units

TYPE: Housing units, Plummer block, Cast iron housing, Radial insert ball bearing with grub screws in inner ring, With inner ring extended on both sides, massive bearing units

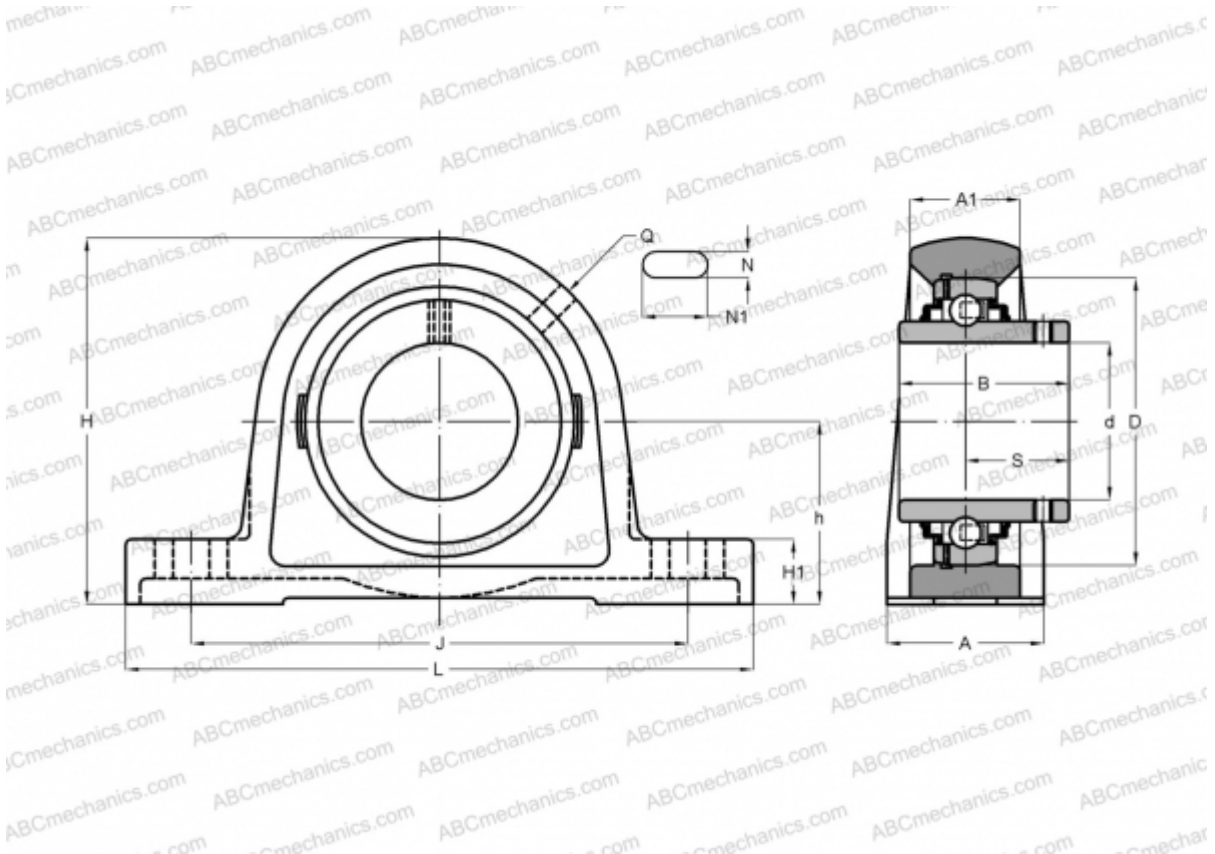

Technical specification

DIMENSIONS, MM

d	15,000
D	47,000
L	127,000
H	65,000
A	22,000
J	95,000
A1	38,000
H1	15,000
N	13,000
N1	19,000
S	18,300
h	33,300
Q	M6x1

WEIGHT, KG 0,700

CALCULATION DATA

Operating temperature max	110 °C
---------------------------	--------

Bearing	UC202
Housing	P204

MANUFACTURER [SNR](#)

INTERCHANGE

ABC	UCP202
ASAHI	UCP 202
SLB	UCP202
FYH	UCP 202
NTN	UCP 202 D1

CALCULATION DATA

Basic dynamic load rating, C	12,800 kN
Basic static load rating, Co	6,650 kN
Operating temperature min	-20 °C