

UCP308 ABC

Ball bearing units

TYPE: Housing units, Plummer block, Cast iron housing, Radial insert ball bearing with grub screws in inner ring, With inner ring extended on both sides, massive bearing units

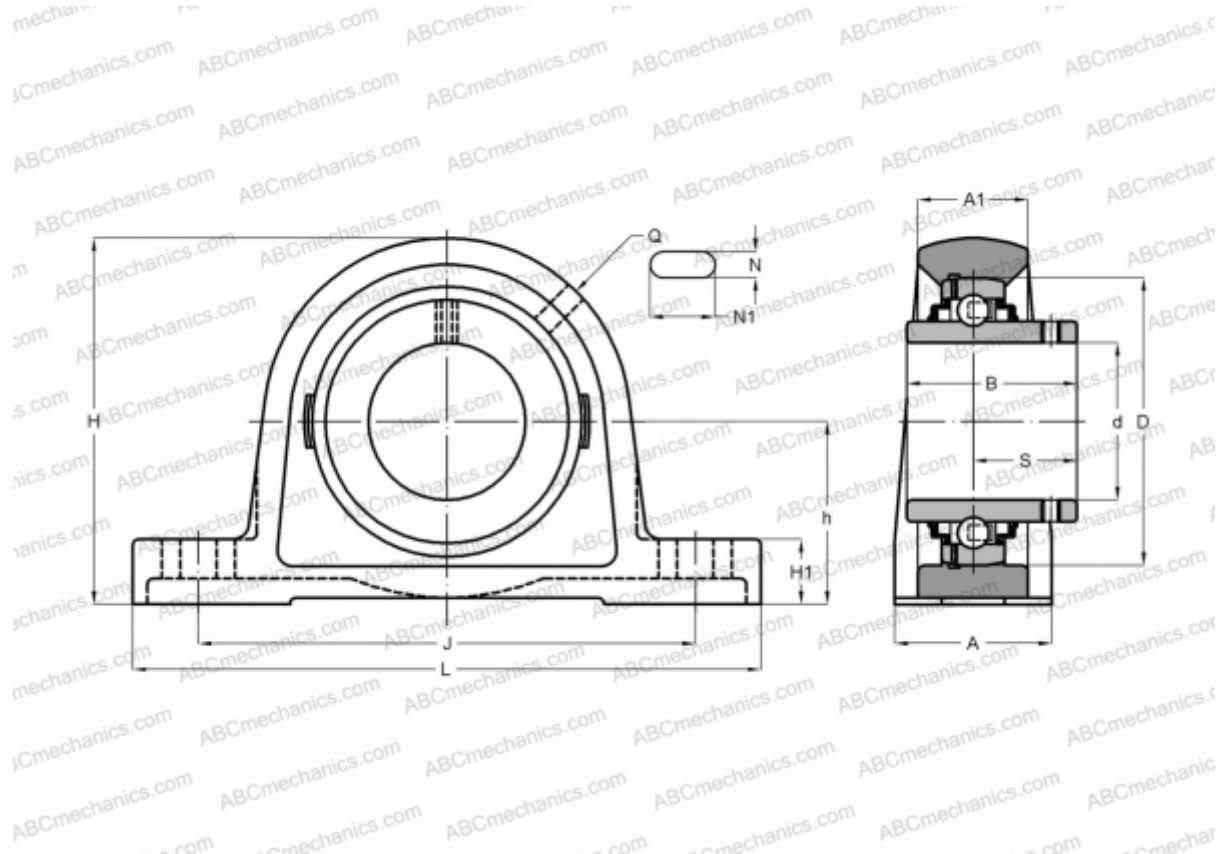

Technical specification

DIMENSIONS, MM

d	40,000
D	90,000
L	220,000
H	116,000
A	42,000
J	170,000
A1	60,000
H1	22,000
N	17,000
N1	27,000
S	33,000
h	60,000
Q	M6x1

WEIGHT 3,300

Bearing	UC308
Housing	P308

MANUFACTURER

[ABC](#)

INTERCHANGE

ASAHI	UCP 308
SNR	UCP308
SLB	UCP 308
FYH	UCP 308
NTN	UCP 308 D1