

RASEY15 INA

Ball bearing units

TYPE: Housing units, Plummer block, Cast iron housing, Radial insert ball bearing with grub screws in inner ring, With inner ring extended on both sides

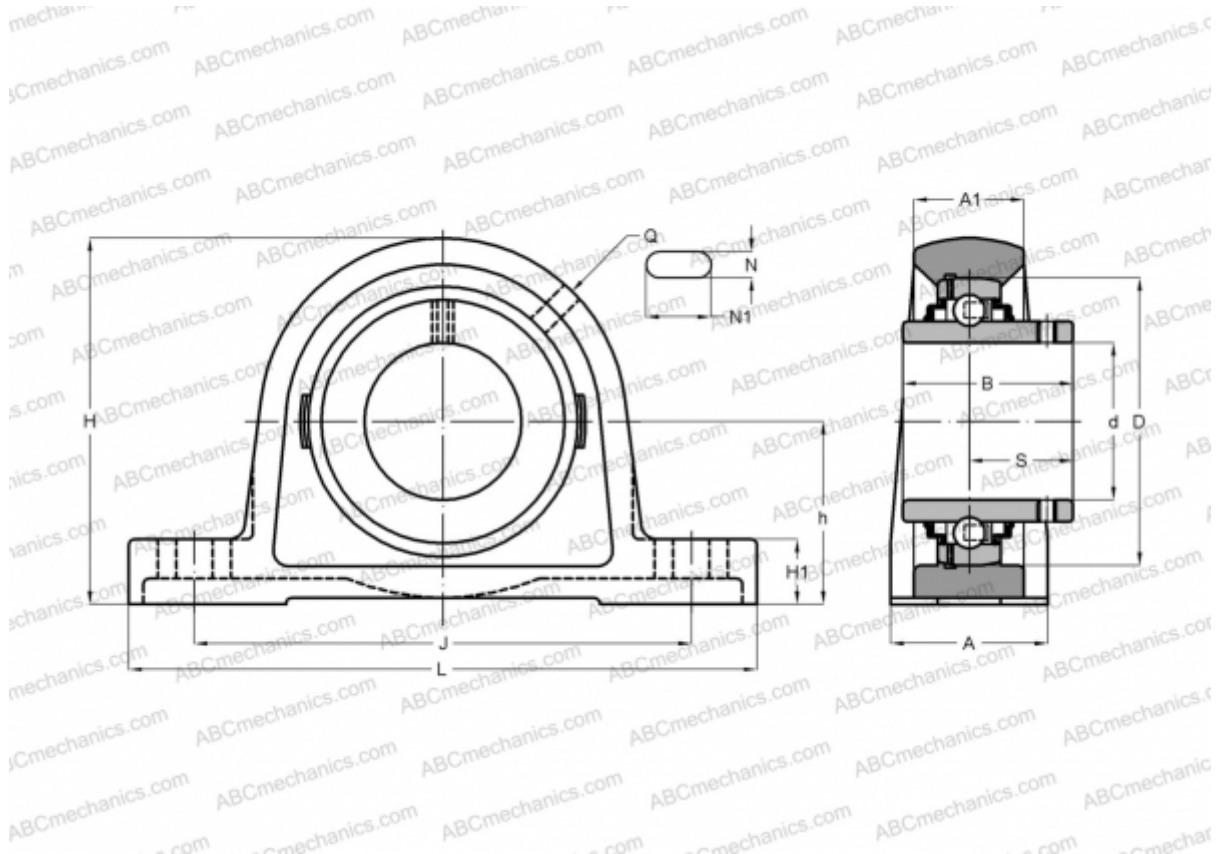

Technical specification

DIMENSIONS, MM

d	15,000
D	40,000
B	27,400
L	125,000
H	57,000
A	30,000
J	95,000
A1	18,000
H1	10,000
N	11,000
N1	19,000
S	15,900
h	30,200
Q	M6

WEIGHT, KG

	0,450
Bearing	GYE15-KRR-B
Housing	GG.ASE03

MANUFACTURER

[INA](#)

INTERCHANGE

ABC	RASEY15
SKF	SY 15 TF

CALCULATION DATA

Basic dynamic load rating, C	9,800 kN
Basic static load rating, Co	4,750 kN