

USPLE202 ABC

Подшипниковые узлы

TYPE: Housing units, Plummer block, Cast iron housing, Radial insert ball bearing with grub screws in inner ring, With inner ring extended at one side, wide base

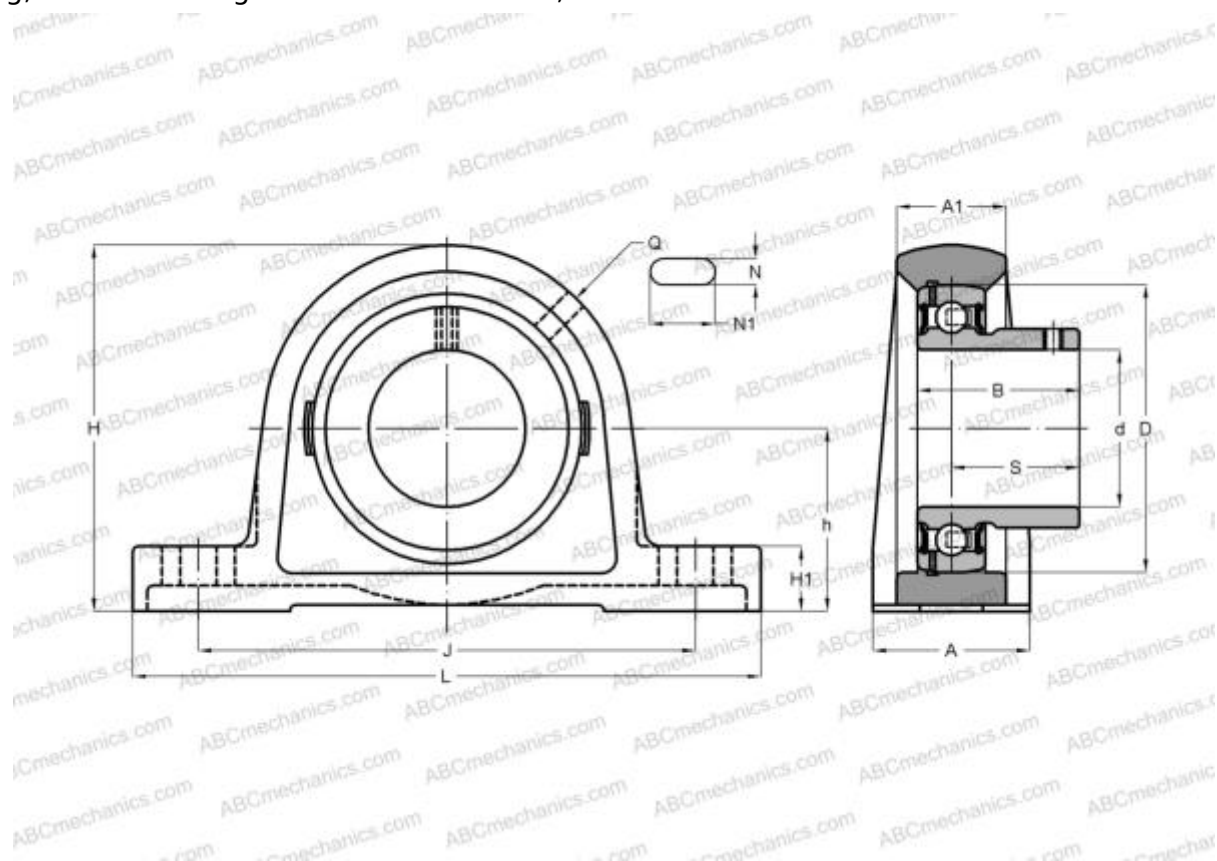

Technical specification

DIMENSIONS, MM

d	15,000
D	40,000
B	22,000
L	119,000
H	54,000
A	30,000
J	88,500
A1	20,500
H1	11,000
N	11,000
N1	14,000
S	16,000
h	27,000
Q	M6x1

WEIGHT, KG

0,400

MANUFACTURER

[ABC](#)

INTERCHANGE

SNR

[USPLE202](#)