

USPLE203 SNR

Подшипниковые узлы

TYPE: Housing units, Plummer block, Cast iron housing, Radial insert ball bearing with grub screws in inner ring, With inner ring extended at one side, wide base

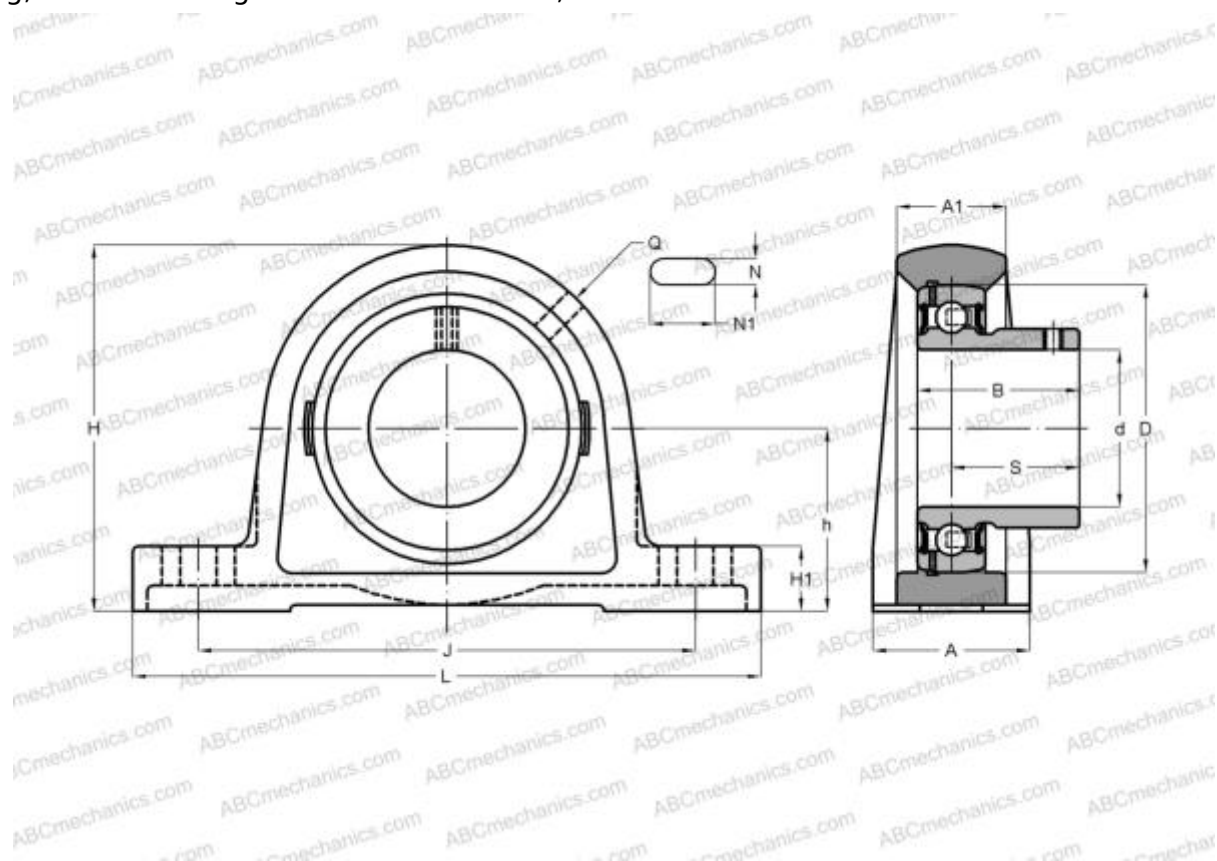

Technical specification

DIMENSIONS, MM

d	17,000
D	40,000
B	22,000
L	119,000
H	54,000
A	30,000
J	88,500
A1	20,500
H1	11,000
N	11,000
N1	14,000
S	16,000
h	27,000
Q	M6x1

WEIGHT, KG

	0,400
Bearing	US203
Housing	PLE203

MANUFACTURER

[SNR](#)

INTERCHANGE

ABC	USPLE203
-----	--------------------------

CALCULATION DATA

Basic dynamic load rating, C	9,550 kN
Basic static load rating, Co	4,780 kN
Operating temperature min	-20 °C
Operating temperature max	110 °C