

USPAE202 SNR

Ball bearing units

TYPE: Housing units, Plummer block, Narrow cast iron housing, Radial insert ball bearing with grub screws in inner ring, With inner ring extended at one side

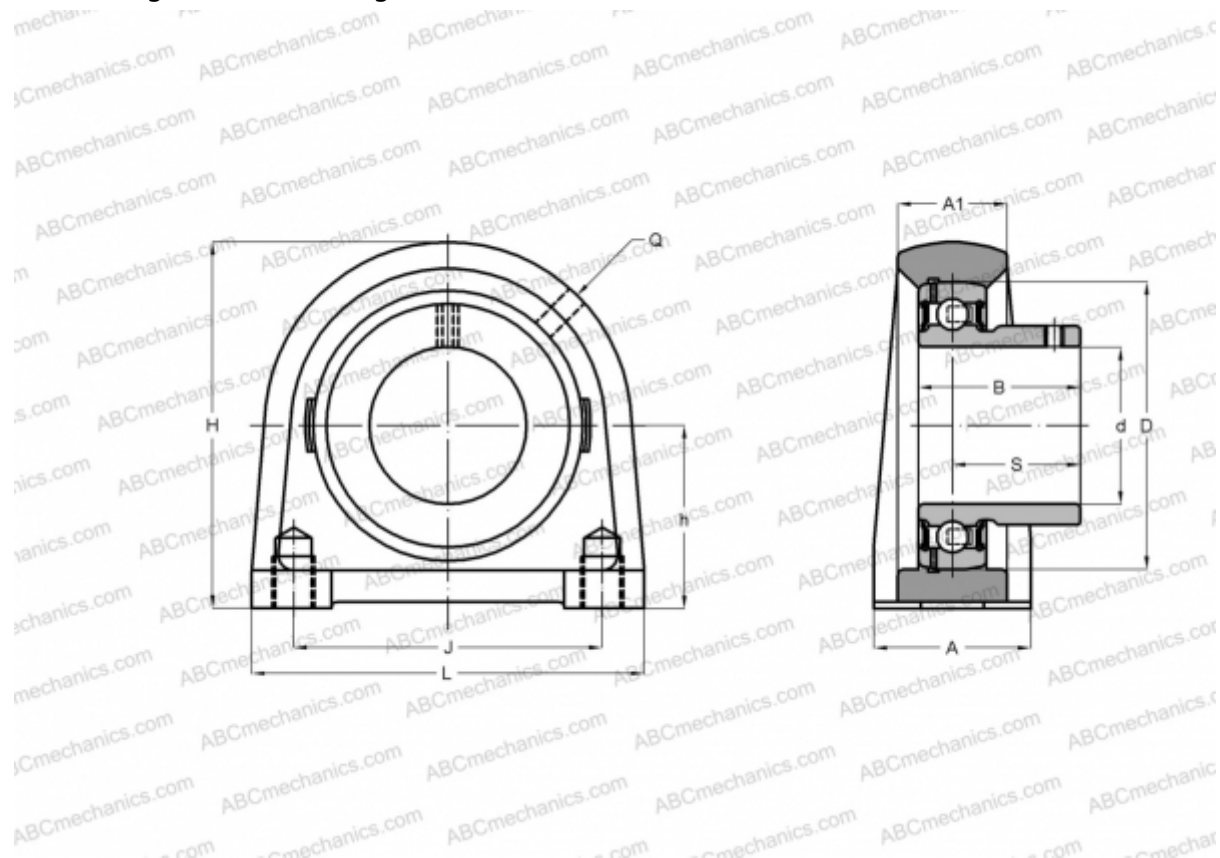

Technical specification

DIMENSIONS, MM

d	15,000
D	40,000
B	22,000
L	63,000
H	57,000
A	30,000
J	47,000
A1	18,000
H1	9,000
S	16,000
h	30,200
Q	M6x1

WEIGHT, KG 0,300

Bearing	US202
Housing	PAE203

MANUFACTURER

[SNR](#)

INTERCHANGE

ABC	USPAE202
INA	PSHEY15

CALCULATION DATA

Basic dynamic load rating, C	9,550 kN
Basic static load rating, Co	4,780 kN
Operating temperature min	-20 °C
Operating temperature max	110 °C