

## EXPG205 ABC

Ball bearing units

TYPE: Housing units, Plummer block, Narrow cast iron housing, Radial insert ball bearing with eccentric locking collar, With inner ring extended on both sides, wide base

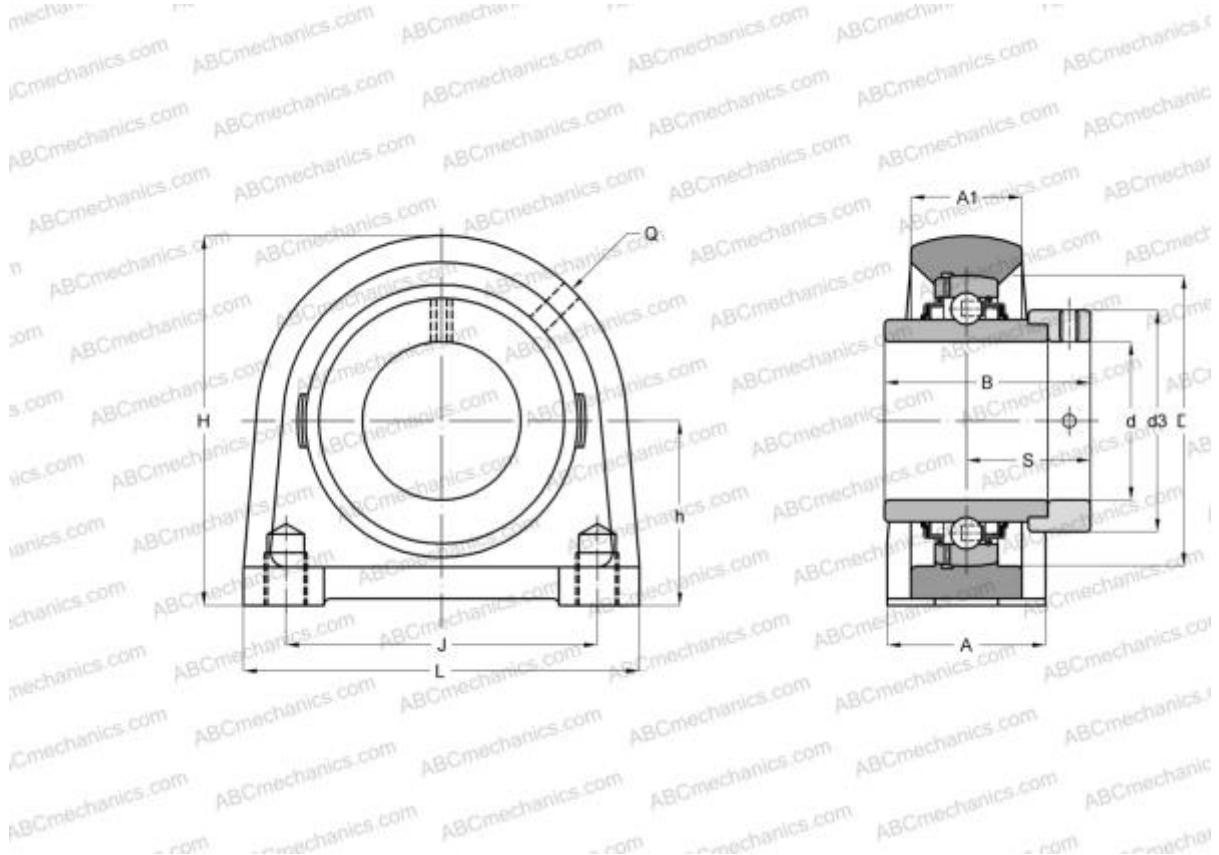

### Technical specification

#### DIMENSIONS, MM

d	25,000
D	52,000
B	44,300
L	75,000
H	70,000
A	38,000
J	50,000
A1	25,000
H1	15,000
S	26,900
d3	38,100
h	36,500
Q	M6x1

Bearing	EX205
Housing	PG205

**MANUFACTURER** [ABC](#)

**INTERCHANGE**  
SNR [EXPG205](#)

**WEIGHT, KG** 0,700