

UCPG205 ABC

Ball bearing units

TYPE: Housing units, Plummer block, Narrow cast iron housing, Radial insert ball bearing with grub screws in inner ring, With inner ring extended on both sides, wide base

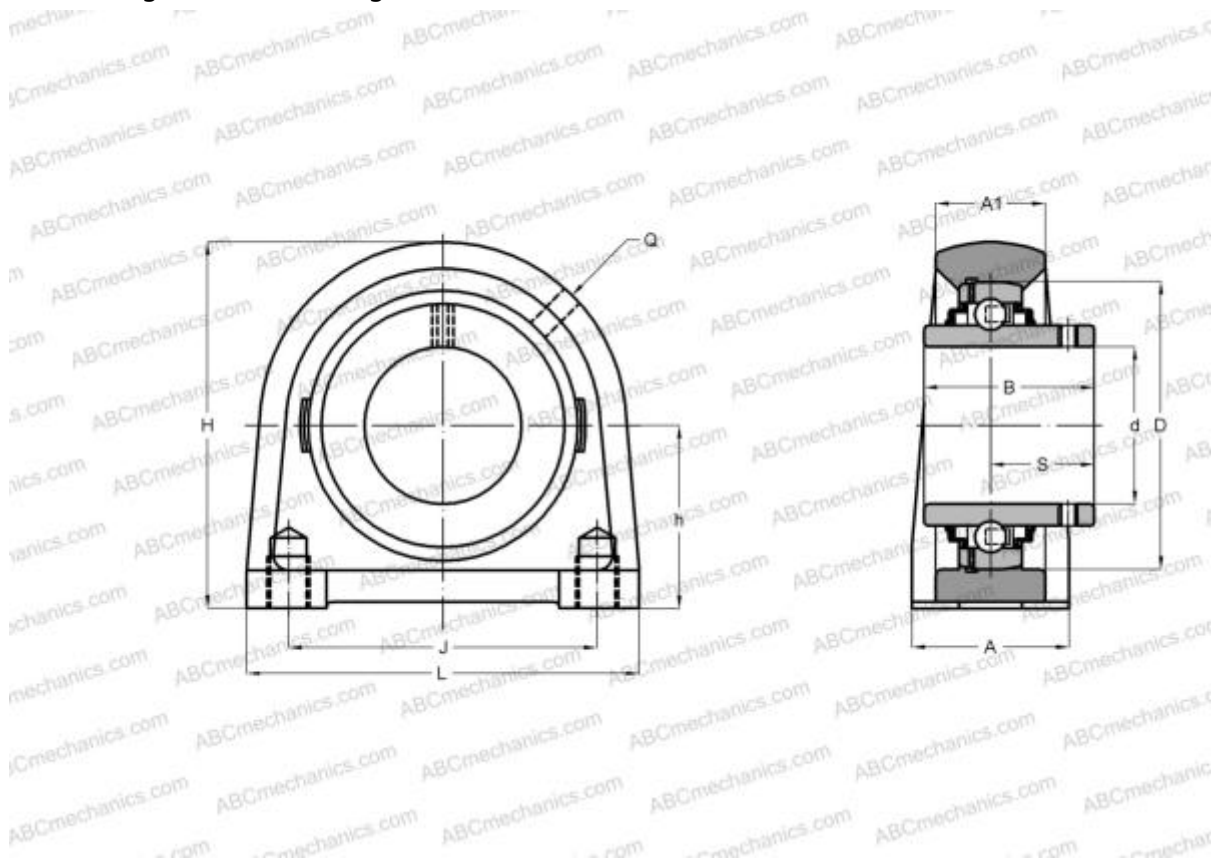

Technical specification

DIMENSIONS, MM

d	25,000
D	52,000
B	34,000
L	75,000
H	70,000
A	38,000
J	50,000
A1	25,000
H1	15,000
S	19,700
h	36,500
Q	M6x1

WEIGHT, KG 0,700

Bearing	UC205
Housing	PG205

MANUFACTURER [ABC](#)

INTERCHANGE
SNR [UCPG205](#)