

USPA203 ABC

Ball bearing units

TYPE: Housing units, Plummer block, Narrow cast iron housing, Radial insert ball bearing with grub screws in inner ring, With inner ring extended at one side, wide base, massive bearing units

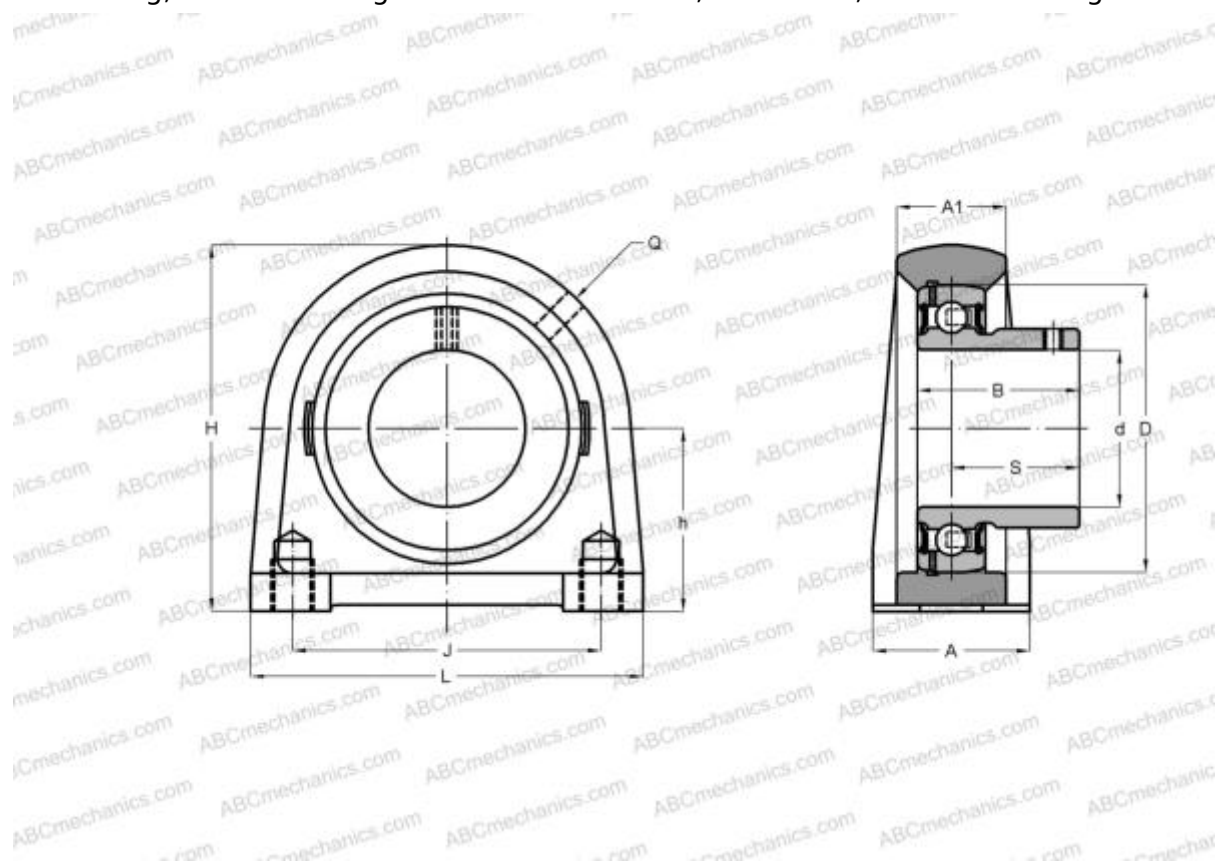

Technical specification

DIMENSIONS, MM

d	17,000
D	40,000
B	22,000
L	70,000
H	57,000
A	36,000
J	48,000
A1	19,000
H1	10,000
S	16,000
h	30,200
Q	M6x1

WEIGHT, KG 0,400

Bearing	US203
Housing	PA203

MANUFACTURER [ABC](#)

INTERCHANGE [USPA203](#)
SNR