

EXPA205 SNR

Ball bearing units

TYPE: Housing units, Plummer block, Narrow cast iron housing, Radial insert ball bearing with eccentric locking collar, With inner ring extended on both sides, massive bearing units

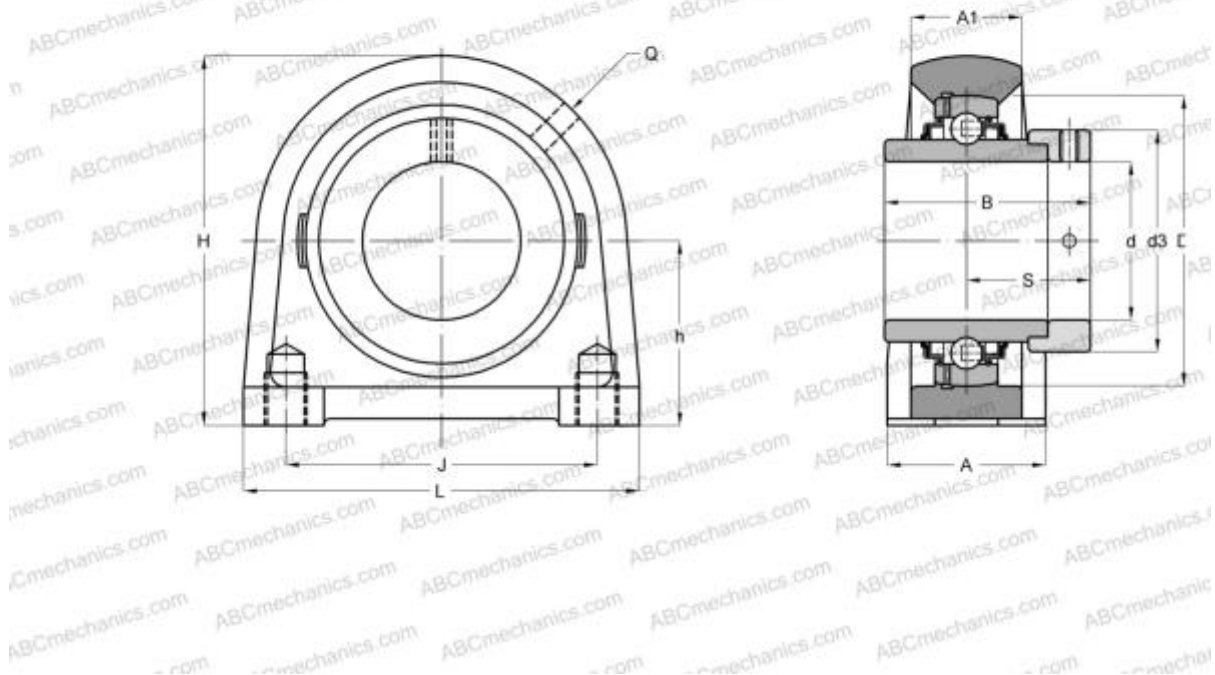

Technical specification

DIMENSIONS, MM

d	25,000
D	52,000
B	44,300
L	84,000
H	72,000
A	38,000
J	56,000
A1	23,000
H1	12,000
S	26,900
d3	38,100
h	36,500
Q	M6x1

Bearing	EX205
Housing	PA205

MANUFACTURER

[SNR](#)

INTERCHANGE

ABC	EXPA205
-----	-------------------------

CALCULATION DATA

Basic dynamic load rating, C	14,000 kN
Basic static load rating, Co	7,880 kN
Operating temperature min	-20 °C
Operating temperature max	110 °C

WEIGHT, KG 0,800