

ESF202 SNR

Ball bearing units

TYPE: Housing units, Four-bolt flanged housing units, Cast iron housing, Radial insert ball bearing with eccentric locking collar, With inner ring extended at one side

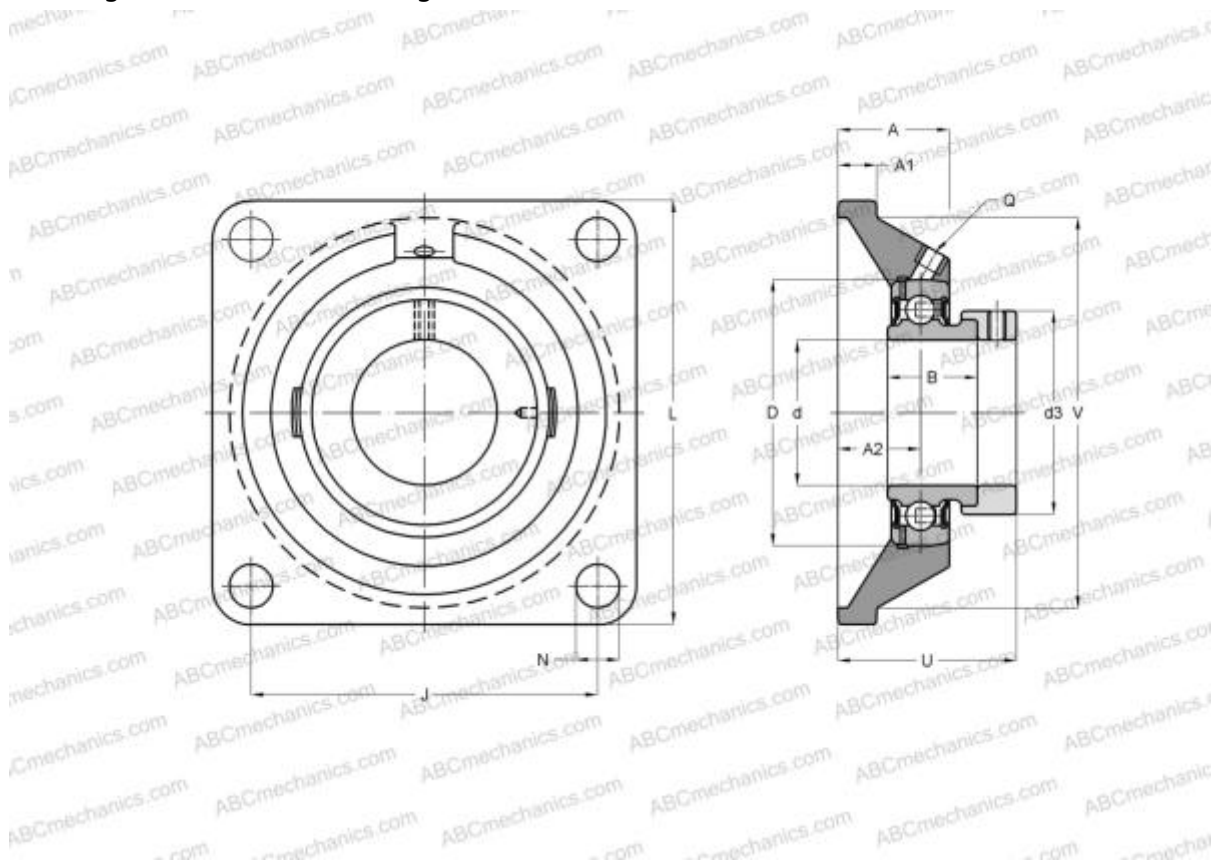

Technical specification

DIMENSIONS, MM

d	15,000
D	40,000
B	28,600
L	76,000
A	25,500
J	54,000
A1	11,000
A2	15,000
N	12,000
d3	28,600
U	37,100
Q	M6x1

WEIGHT, KG

0,500

Bearing	ES202
Housing	F203

MANUFACTURER

[SNR](#)

INTERCHANGE

ABC	ESF202
-----	------------------------

CALCULATION DATA

Basic dynamic load rating, C	9,550 kN
Basic static load rating, Co	4,780 kN
Operating temperature min	-20 °C
Operating temperature max	110 °C