

ESF204 ABC

Ball bearing units

TYPE: Housing units, Four-bolt flanged housing units, Cast iron housing, Radial insert ball bearing with eccentric locking collar, With inner ring extended at one side

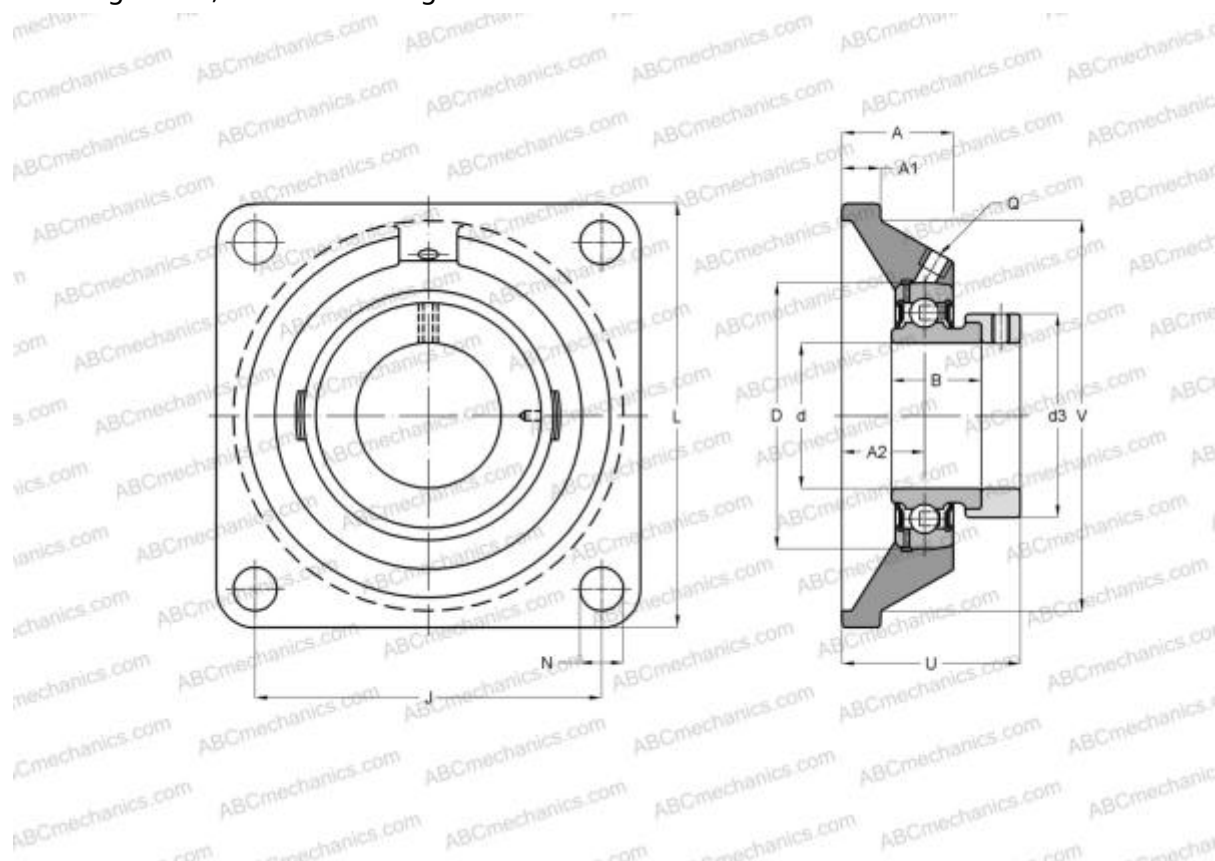

Technical specification

DIMENSIONS, MM

d	20,000
D	47,000
B	30,900
L	86,000
A	25,500
J	64,000
A1	11,000
A2	15,000
N	12,000
d3	33,300
U	38,400
Q	M6x1

WEIGHT, KG 0,600

Bearing	ES204
Housing	F204

MANUFACTURER [ABC](#)

INTERCHANGE
SNR [ESF204](#)