

PCJ17 INA

Ball bearing units

TYPE: Housing units, Four-bolt flanged housing units, Cast iron housing, Radial insert ball bearing with eccentric locking collar, With inner ring extended at one side, wide base, massive bearing units

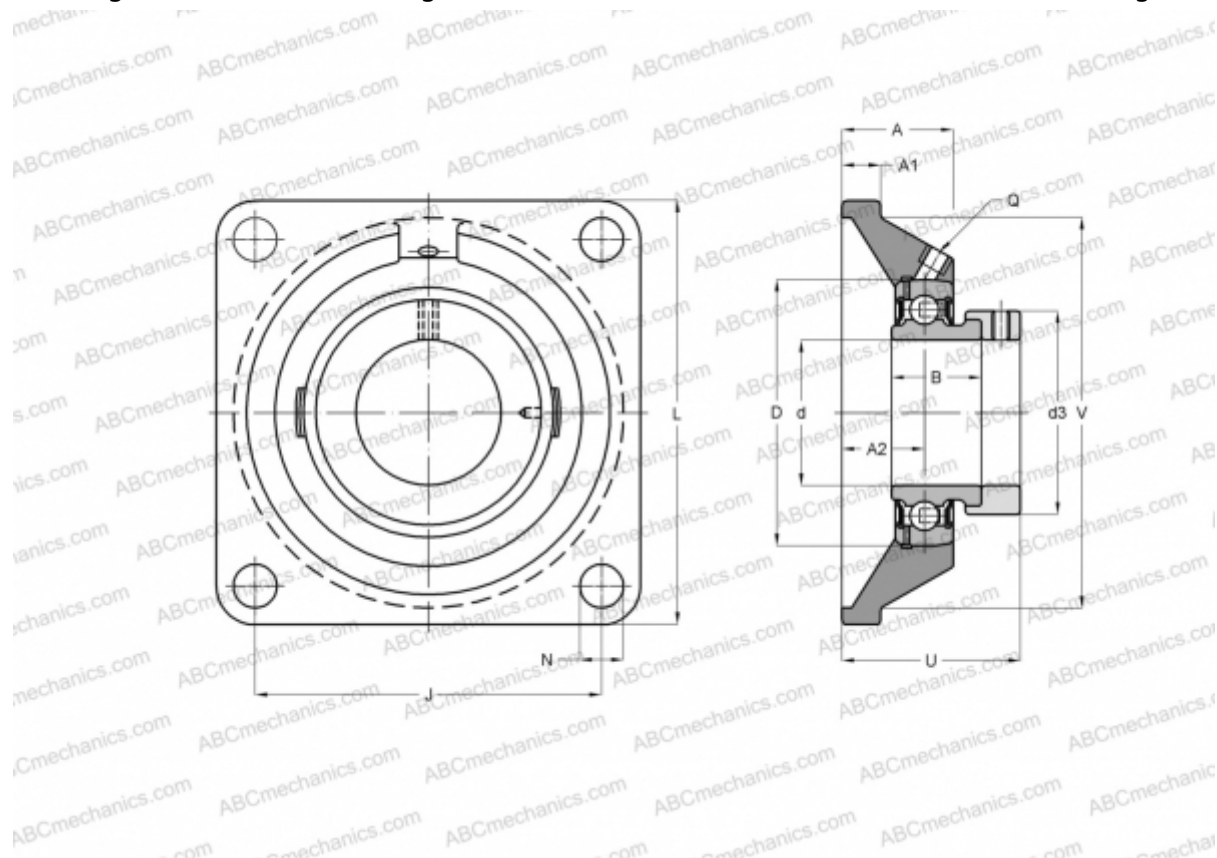

Technical specification

DIMENSIONS, MM

d	17,000
D	40,000
B	28,600
L	76,000
A	27,000
J	54,000
A1	9,500
A2	17,000
N	11,500
d3	28,000
U	39,100
V	58,000
Q	M6

Bearing	GRAE17-NPP-B
Housing	GG.CJ03

MANUFACTURER

[INA](#)

INTERCHANGE

ABC	ESFE203
SKF	FY 17 FM
SNR	ESFE203

CALCULATION DATA

Basic dynamic load rating, C	9,800 kN
Basic static load rating, Co	4,750 kN

WEIGHT, KG 0,520