

## ESFE203 SNR

Ball bearing units

TYPE: Housing units, Four-bolt flanged housing units, Cast iron housing, Radial insert ball bearing with eccentric locking collar, With inner ring extended at one side, wide base, massive bearing units

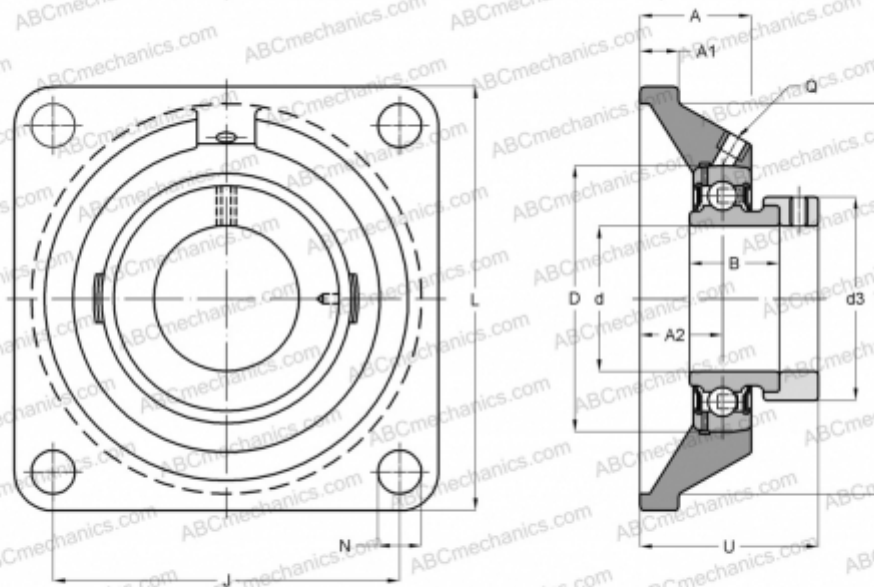

### Technical specification

#### DIMENSIONS, MM

d	17,000
D	40,000
B	28,600
L	76,000
A	31,000
J	54,000
A1	9,500
A2	17,000
N	11,500
d3	28,600
U	39,100
Q	M6x1

#### WEIGHT, KG

0,500

Bearing	ES203
Housing	FE203

#### MANUFACTURER

[SNR](#)

#### INTERCHANGE

ABC	<a href="#">ESFE203</a>
INA	<a href="#">PCJ17</a>
SKF	<a href="#">FY 17 FM</a>

#### CALCULATION DATA

Basic dynamic load rating, C	9,550 kN
Basic static load rating, Co	4,780 kN
Operating temperature min	-20 °C
Operating temperature max	110 °C