

EXF203 SNR

Ball bearing units

TYPE: Housing units, Four-bolt flanged housing units, Cast iron housing, Radial insert ball bearing with eccentric locking collar, With inner ring extended on both sides

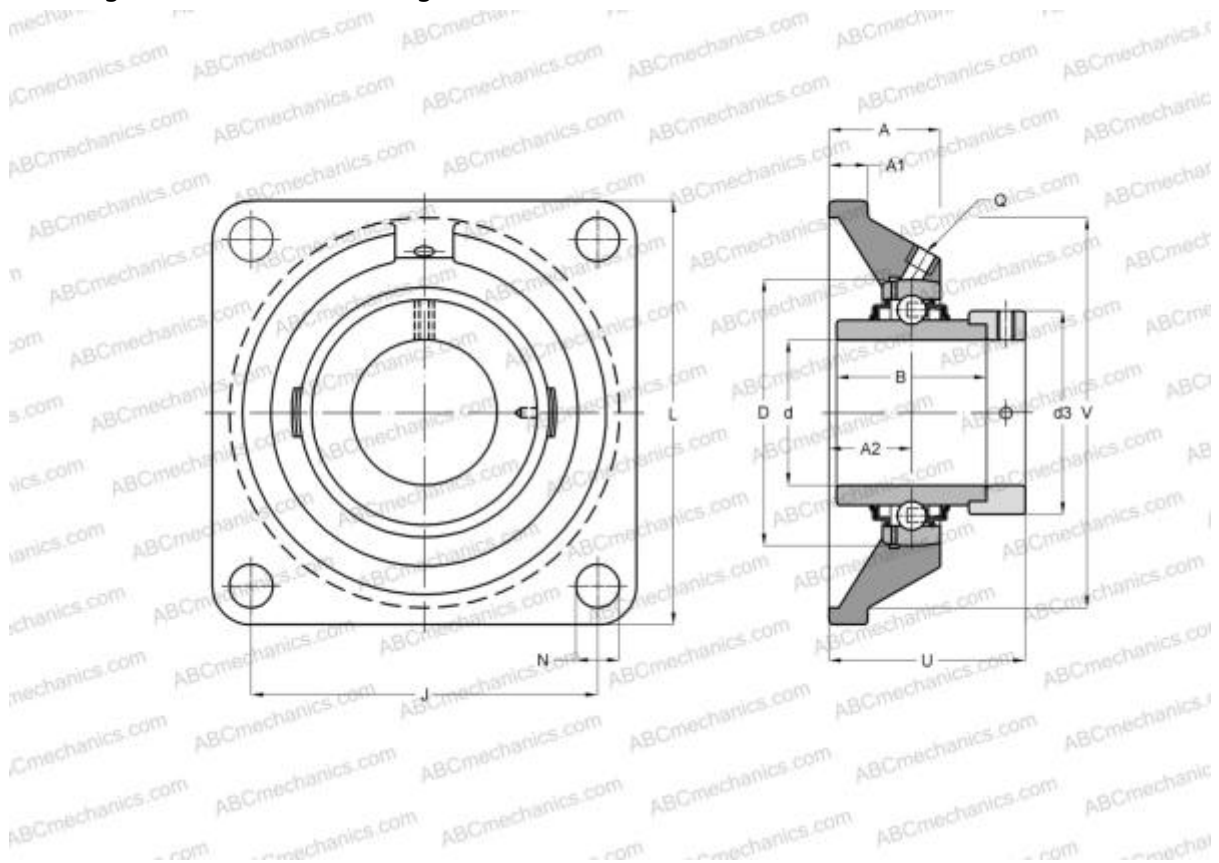

Technical specification

DIMENSIONS, MM

d	17,000
D	47,000
B	43,500
L	86,000
A	25,500
J	64,000
A1	11,000
A2	15,000
N	12,000
d3	33,300
U	41,500
Q	M6x1

WEIGHT, KG

0,700

Bearing	EX203
Housing	F204

MANUFACTURER

[SNR](#)

INTERCHANGE

ABC	EXF203
-----	------------------------

CALCULATION DATA

Basic dynamic load rating, C	12,800 kN
Basic static load rating, Co	6,650 kN
Operating temperature min	-20 °C
Operating temperature max	110 °C