

EXF205 ABC

Ball bearing units

TYPE: Housing units, Four-bolt flanged housing units, Cast iron housing, Radial insert ball bearing with eccentric locking collar, With inner ring extended on both sides

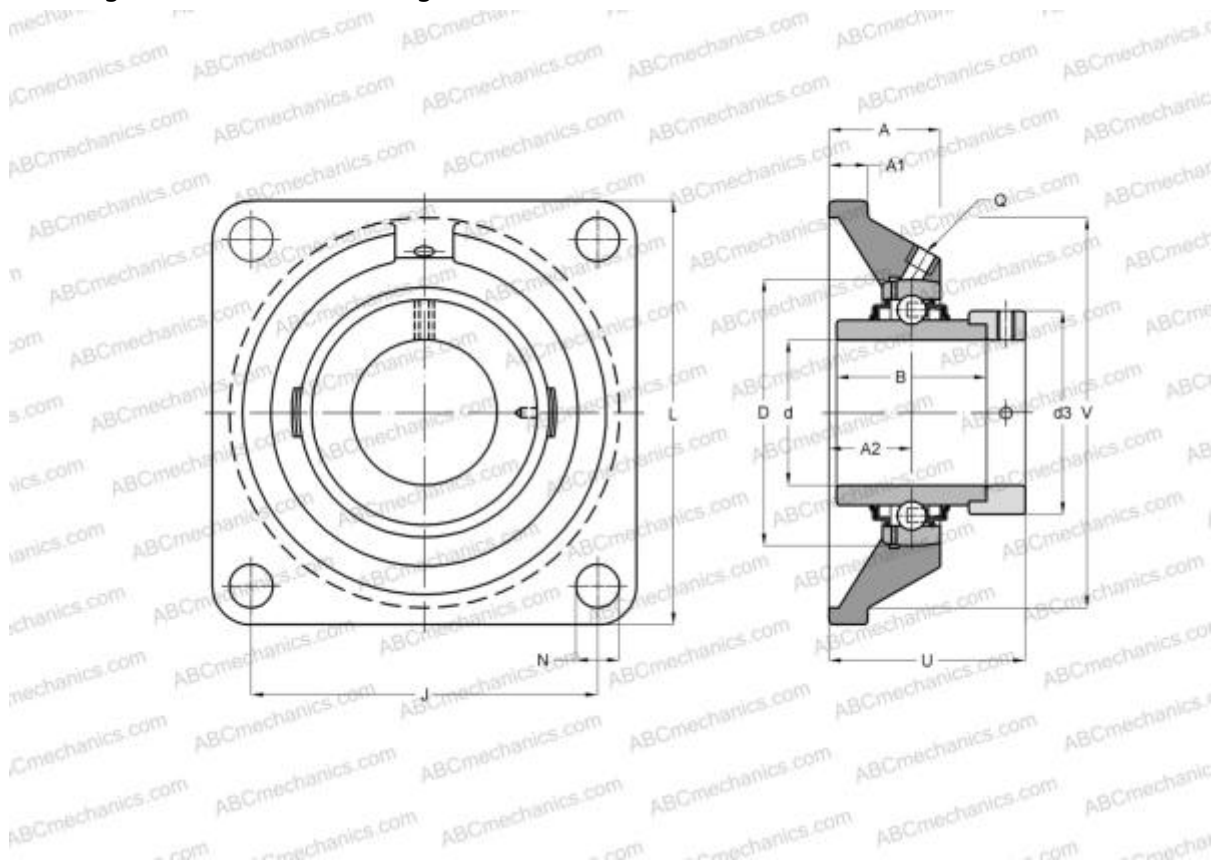

Technical specification

DIMENSIONS, MM

d	25,000
D	52,000
B	44,300
L	95,000
A	27,000
J	70,000
A1	13,000
A2	16,000
N	12,000
d3	38,100
U	42,900
Q	M6x1

WEIGHT, KG 0,900

Bearing	EX205
Housing	F205

MANUFACTURER [ABC](#)

INTERCHANGE
SNR [EXF205](#)