

EXFE203 SNR

Ball bearing units

TYPE: Housing units, Four-bolt flanged housing units, Cast iron housing, Radial insert ball bearing with eccentric locking collar, With inner ring extended on both sides, massive bearing units

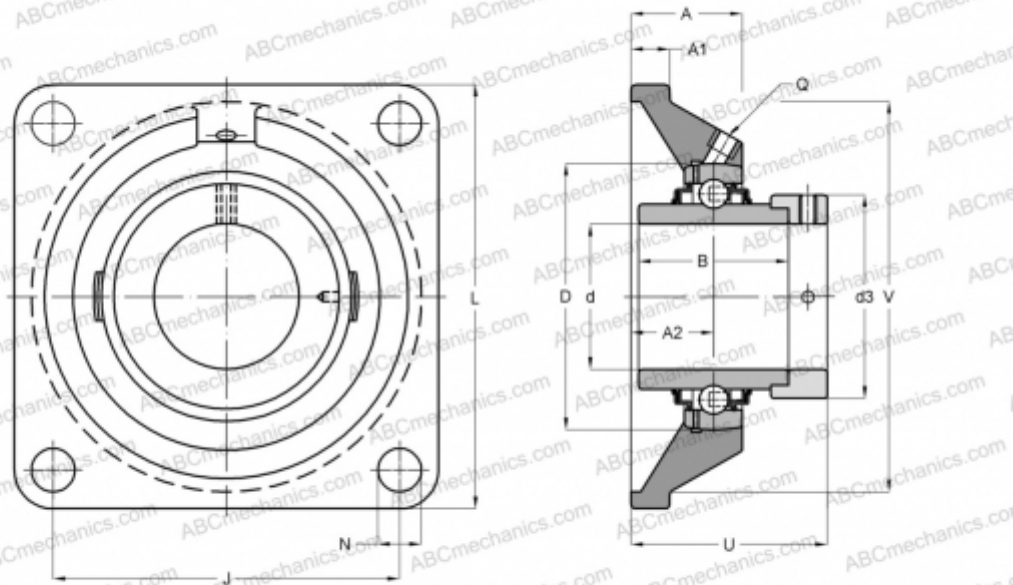

Technical specification

DIMENSIONS, MM

d	17,000
D	47,000
B	43,500
L	86,000
A	29,500
J	63,500
A1	10,000
A2	19,000
N	11,500
d3	33,300
U	45,500
Q	R1/8"

WEIGHT, KG

0,800

Bearing	EX203
Housing	FE204

MANUFACTURER

[SNR](#)

INTERCHANGE

ABC	EXFE203
-----	-------------------------

CALCULATION DATA

Basic dynamic load rating, C	12,800 kN
Basic static load rating, Co	6,650 kN
Operating temperature min	-20 °C
Operating temperature max	110 °C