

PCJY17 INA

Ball bearing units

TYPE: Housing units, Four-bolt flanged housing units, Cast iron housing, Radial insert ball bearing with grub screws in inner ring, With inner ring extended at one side, wide base, massive bearing units

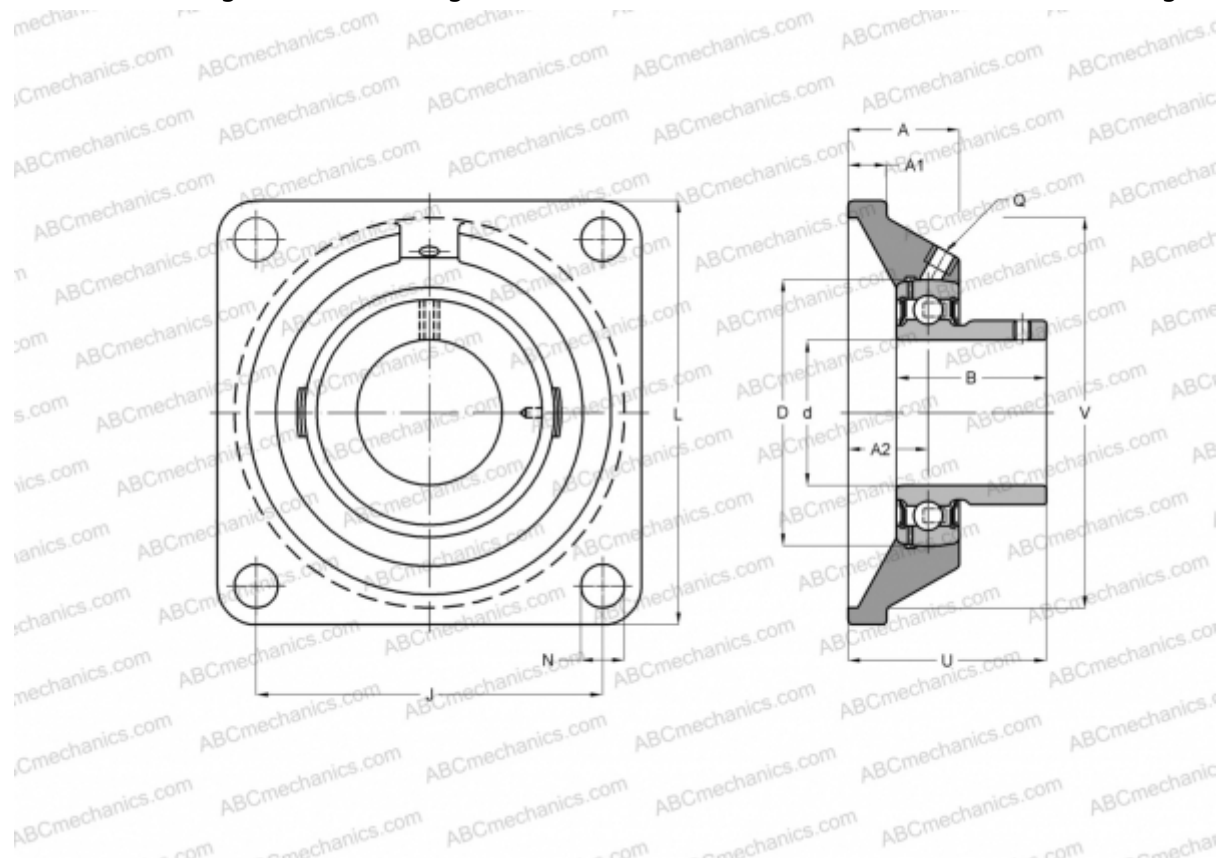

Technical specification

DIMENSIONS, MM

d	17,000
D	40,000
B	22,000
L	76,000
A	27,000
J	54,000
A1	9,500
A2	17,000
N	11,500
U	33,000
V	58,000
Q	M6

WEIGHT, KG 0,480

Bearing	GAY17-NPP-B
Housing	GG.CJ03

MANUFACTURER

[INA](#)

INTERCHANGE

ABC	USFE203
SNR	USFE203

CALCULATION DATA

Basic dynamic load rating, C	9,800 kN
Basic static load rating, Co	4,750 kN