

USFE203 SNR

Ball bearing units

TYPE: Housing units, Four-bolt flanged housing units, Cast iron housing, Radial insert ball bearing with grub screws in inner ring, With inner ring extended at one side, wide base, massive bearing units

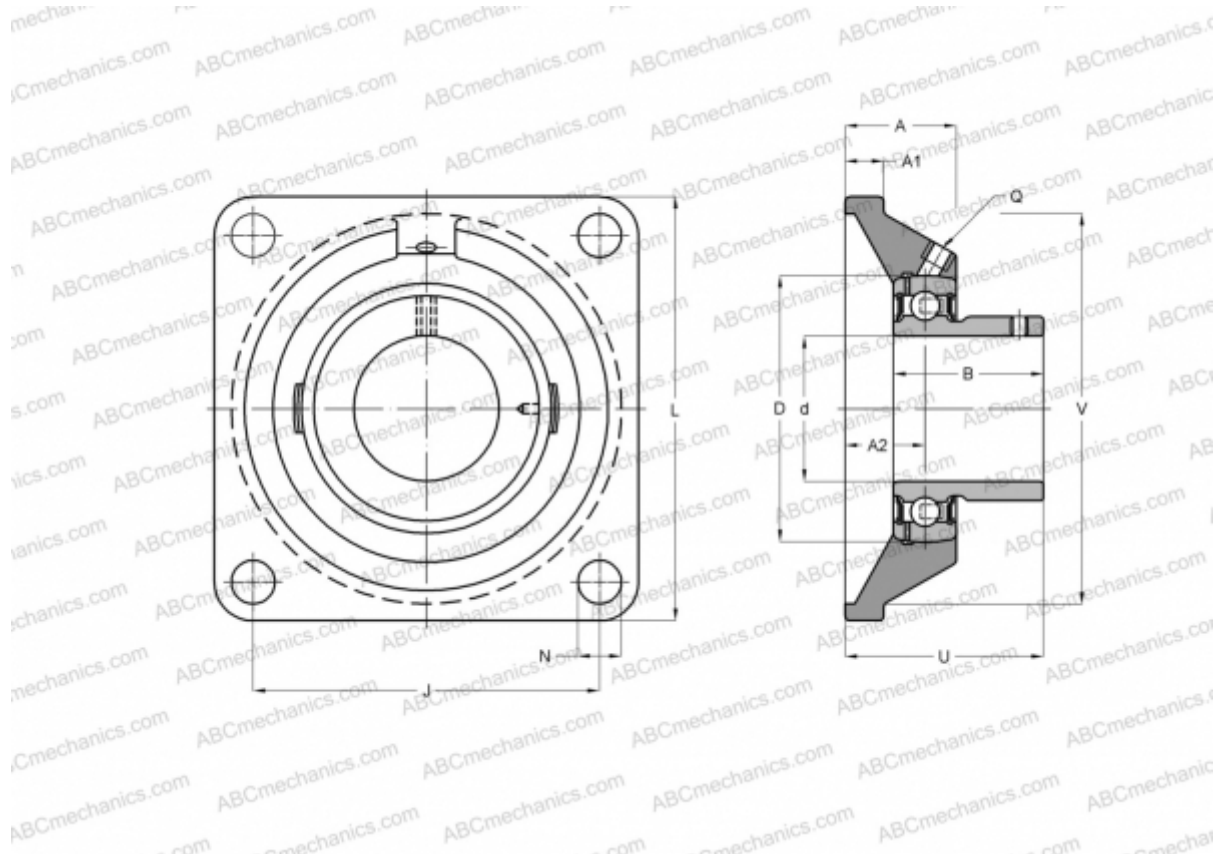

Technical specification

DIMENSIONS, MM

d	17,000
D	40,000
B	22,000
L	76,000
A	31,000
J	54,000
A1	9,500
A2	17,000
N	11,500
U	33,000
Q	M6x1

WEIGHT, KG 0,400

Bearing US203

Housing FE203

MANUFACTURER [SNR](#)

INTERCHANGE

ABC [USFE203](#)

INA [PCJY17](#)

CALCULATION DATA

Basic dynamic load rating, C 9,550 kN

Basic static load rating, Co 4,780 kN

Operating temperature min -20 °C

Operating temperature max 110 °C