

UCF202 ABC

Ball bearing units

TYPE: Housing units, Four-bolt flanged housing units, Cast iron housing, Radial insert ball bearing with grub screws in inner ring, With inner ring extended on both sides

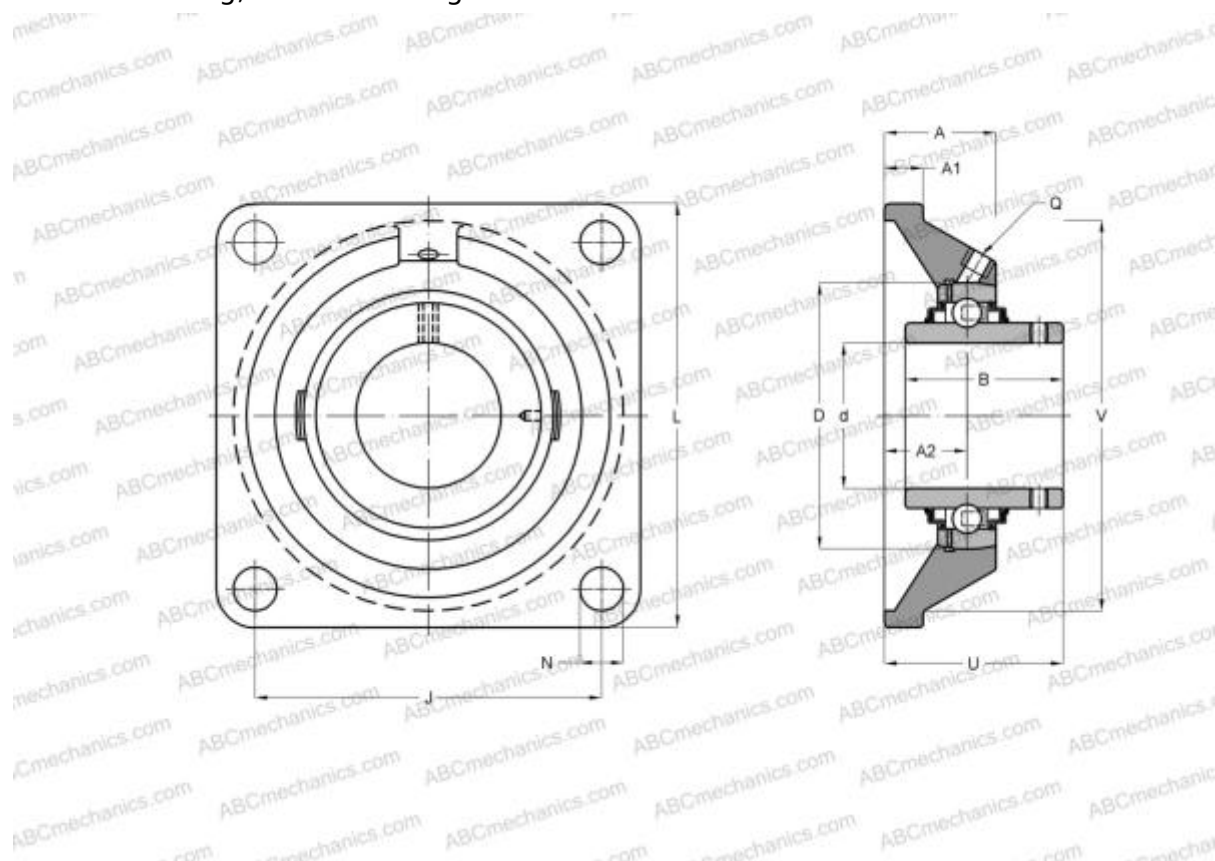

Technical specification

DIMENSIONS, MM

d	15,000
D	47,000
B	31,000
L	86,000
A	25,500
J	64,000
A1	11,000
A2	15,000
N	12,000
U	33,300
Q	M6x1

WEIGHT, KG 0,600

Bearing UC202

Housing F204

MANUFACTURER [ABC](#)

INTERCHANGE

ASAHI	UCF 202
SNR	UCF202
SLB	UCF 202
FYH	UCF202
NTN	UCF 202 D1