

FY 12 TF SKF

Ball bearing units

TYPE: Housing units, Four-bolt flanged housing units, Cast iron housing, Radial insert ball bearing with grub screws in inner ring, With inner ring extended on both sides, massive bearing units

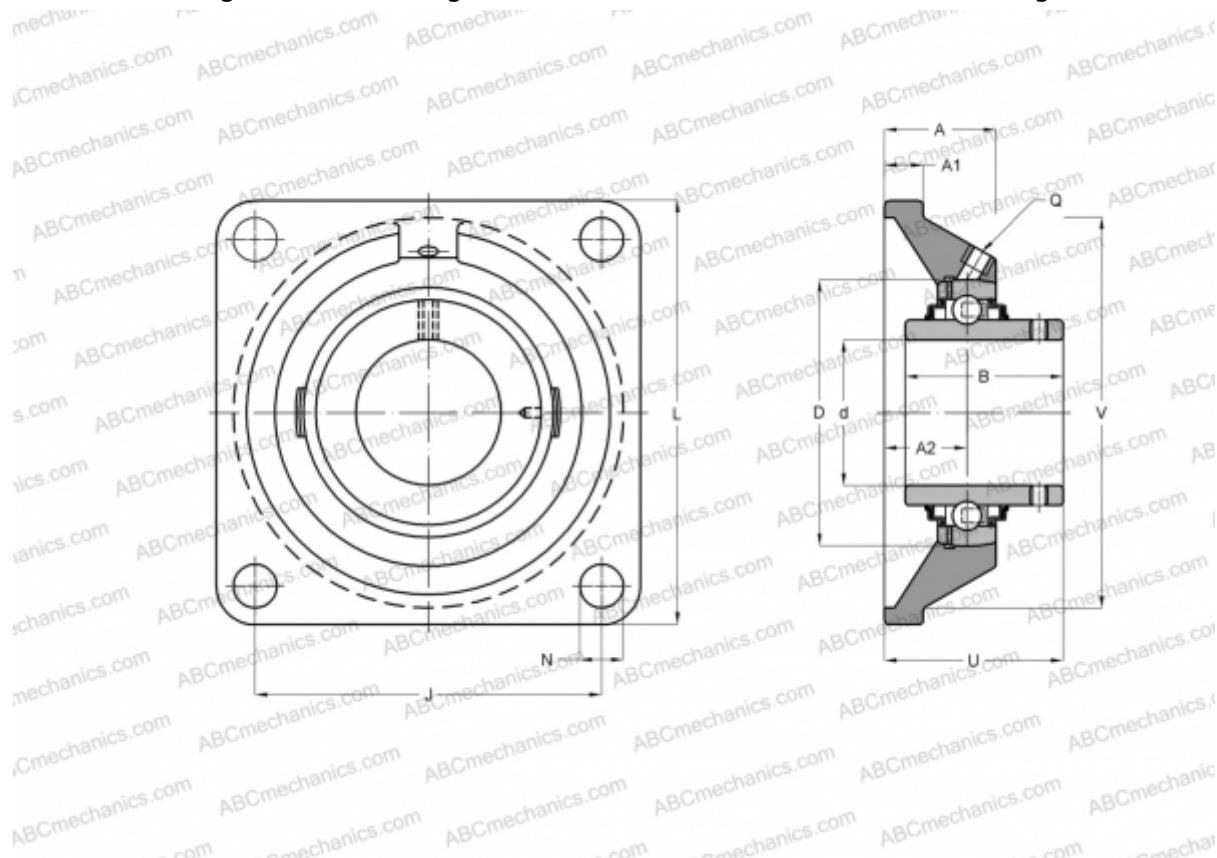

Technical specification

DIMENSIONS, MM

d	12,000
D	40,000
B	27,400
L	76,000
A	26,000
J	54,000
A1	11,000
N	11,500
U	32,900
V	55,600

WEIGHT, KG 0,470

Bearing	YAR 203/12-2F
Housing	FY 503 M

MANUFACTURER

[SKF](#)

INTERCHANGE

ABC	RCJY12
INA	RCJY12

CALCULATION DATA

Basic dynamic load rating, C	9,560 kN
Basic static load rating, Co	4,750 kN
Fatigue load limit, Pu	0,200 kN
Limiting speed	9500 r/min