

UCFE202 ABC

Ball bearing units

TYPE: Housing units, Four-bolt flanged housing units, Cast iron housing, Radial insert ball bearing with grub screws in inner ring, With inner ring extended on both sides, massive bearing units

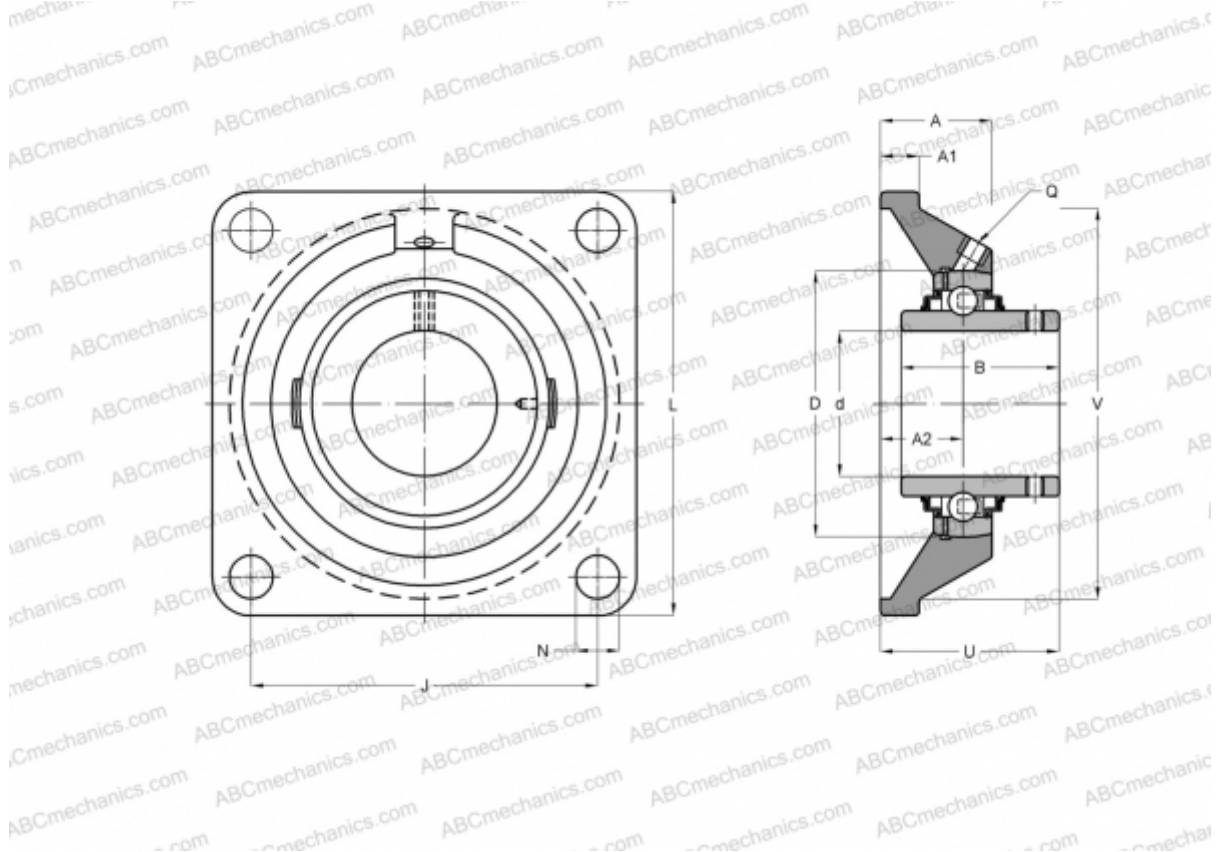

Technical specification

DIMENSIONS, MM

d	15,000
D	47,000
B	31,000
L	86,000
A	29,500
J	63,500
A1	10,000
A2	19,000
N	11,500
U	37,300
Q	R1/8"

WEIGHT, KG 0,700

Bearing UC202

Housing

FE204

MANUFACTURER

[ABC](#)

INTERCHANGE

SNR

[UCFE202](#)