

UCFE202 SNR

Ball bearing units

TYPE: Housing units, Four-bolt flanged housing units, Cast iron housing, Radial insert ball bearing with grub screws in inner ring, With inner ring extended on both sides, massive bearing units

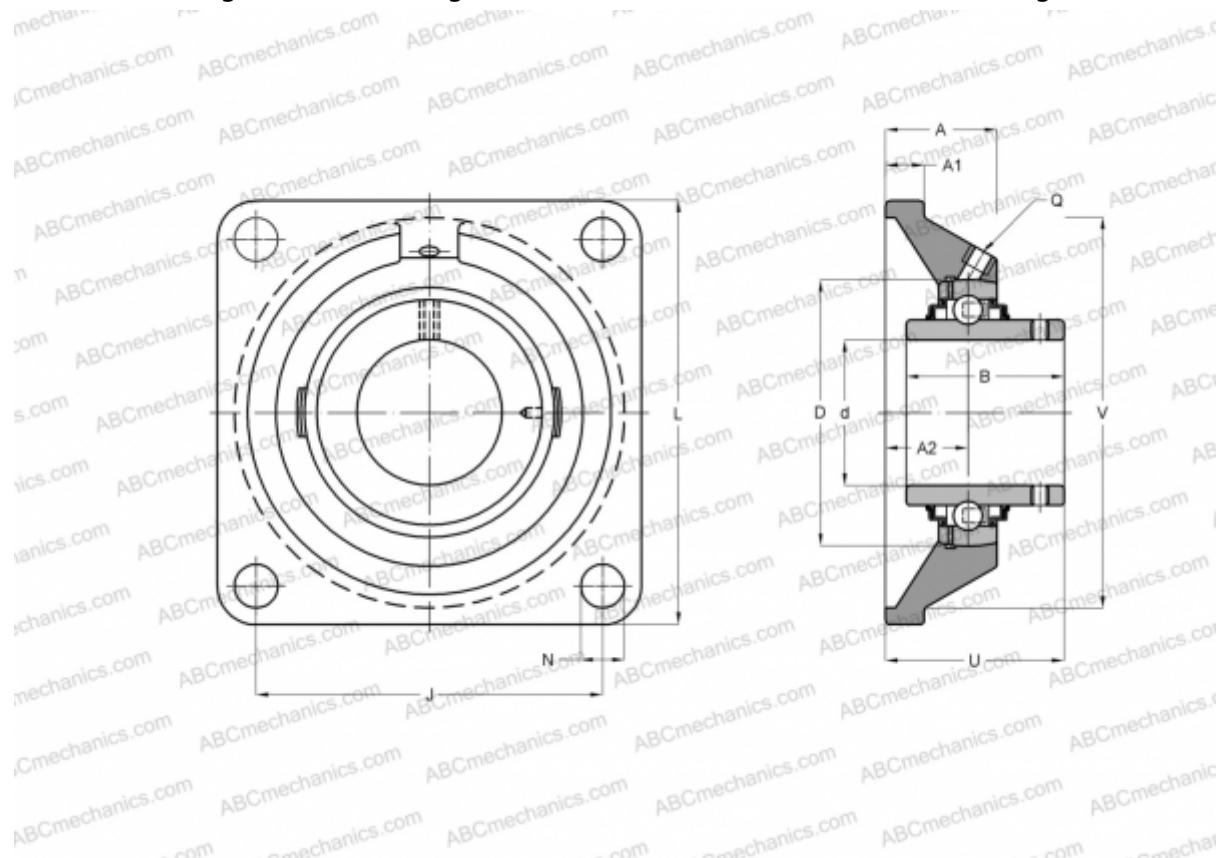

Technical specification

DIMENSIONS, MM

d	15,000
D	47,000
B	31,000
L	86,000
A	29,500
J	63,500
A1	10,000
A2	19,000
N	11,500
U	37,300
Q	R1/8"

WEIGHT, KG 0,700

Bearing UC202

Housing FE204

MANUFACTURER [SNR](#)

INTERCHANGE

ABC [UCFE202](#)

CALCULATION DATA

Basic dynamic load rating, C	12,800 kN
Basic static load rating, Co	6,650 kN
Operating temperature min	-20 °C
Operating temperature max	110 °C