

RCJY15 ABC

Ball bearing units

TYPE: Housing units, Four-bolt flanged housing units, Cast iron housing, Radial insert ball bearing with grub screws in inner ring, With inner ring extended on both sides, massive bearing units

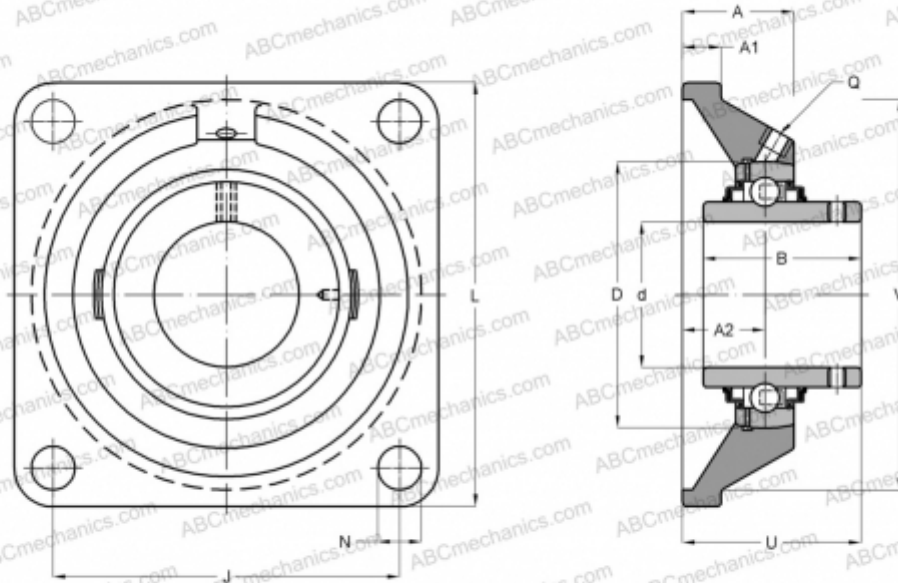

Technical specification

DIMENSIONS, MM

d	15,000
D	40,000
B	27,400
L	76,000
A	27,000
J	54,000
A1	9,500
A2	17,000
N	11,500
U	32,900
V	58,000
Q	M6

WEIGHT, KG 0,510

Bearing	GYE15-KRR-B
Housing	GG.CJ03

MANUFACTURER

[ABC](#)

INTERCHANGE

SKF	FY 15 TF
INA	RCJY15