

UKFE205H ABC

Ball bearing units

TYPE: Housing units, Four-bolt flanged housing units, Cast iron housing, Radial insert ball bearing with adapter sleeve, With inner ring extended on both sides, massive bearing units

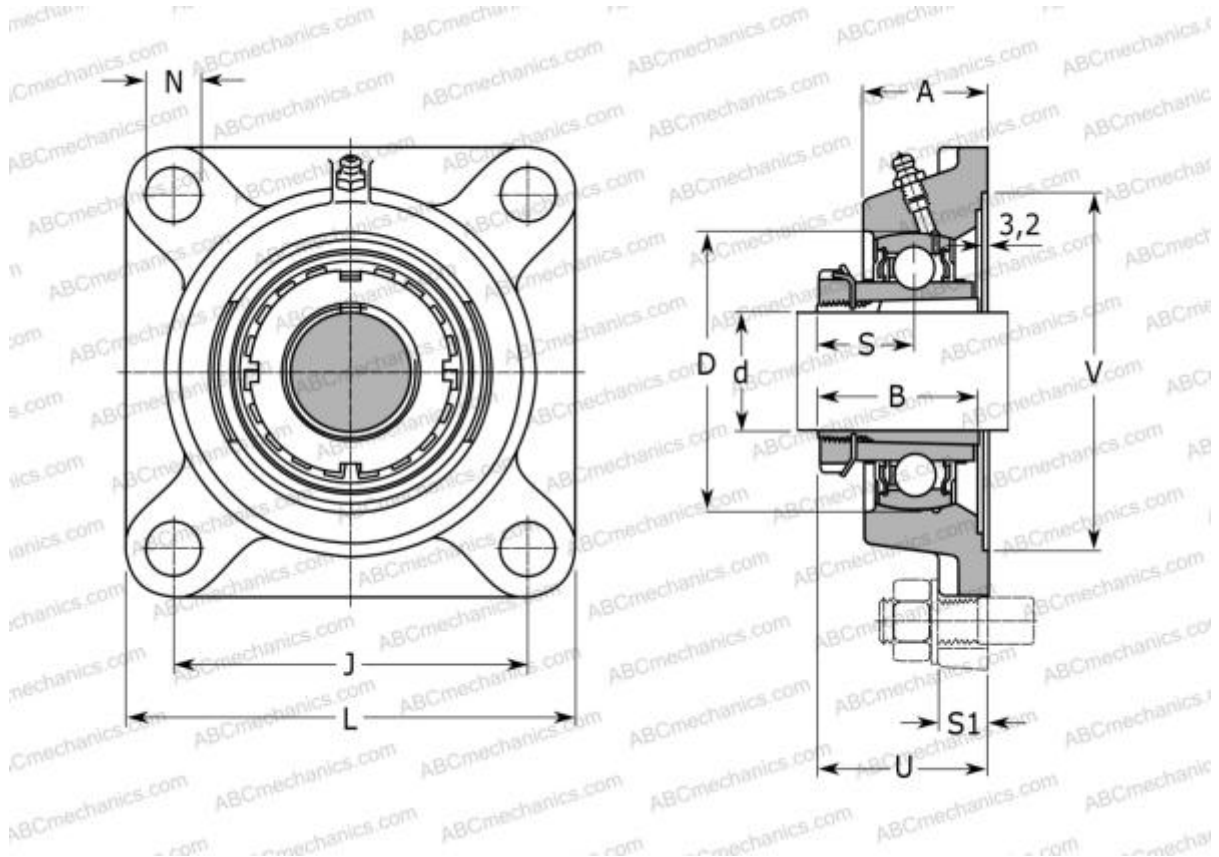

Technical specification

DIMENSIONS, MM

d	20,000
D	52,000
B	35,000
L	95,000
A	30,000
J	70,000
A1	11,000
A2	19,000
N	11,500
S	18,500
d3	38,000
U	37,500
Q	R1/8"

WEIGHT, KG 0,800

Bearing	UK205 +
Housing	FE205
Adapter sleeve	H2305

MANUFACTURER

[ABC](#)

INTERCHANGE

SKF	FYJ 25 KF
SNR	UKFE205H