

## ESFCE203 SNR

Ball bearing units

TYPE: Housing units, Four-bolt flanged housing units, Cast iron housing, Radial insert ball bearing with eccentric locking collar, With inner ring extended at one side, round flanged

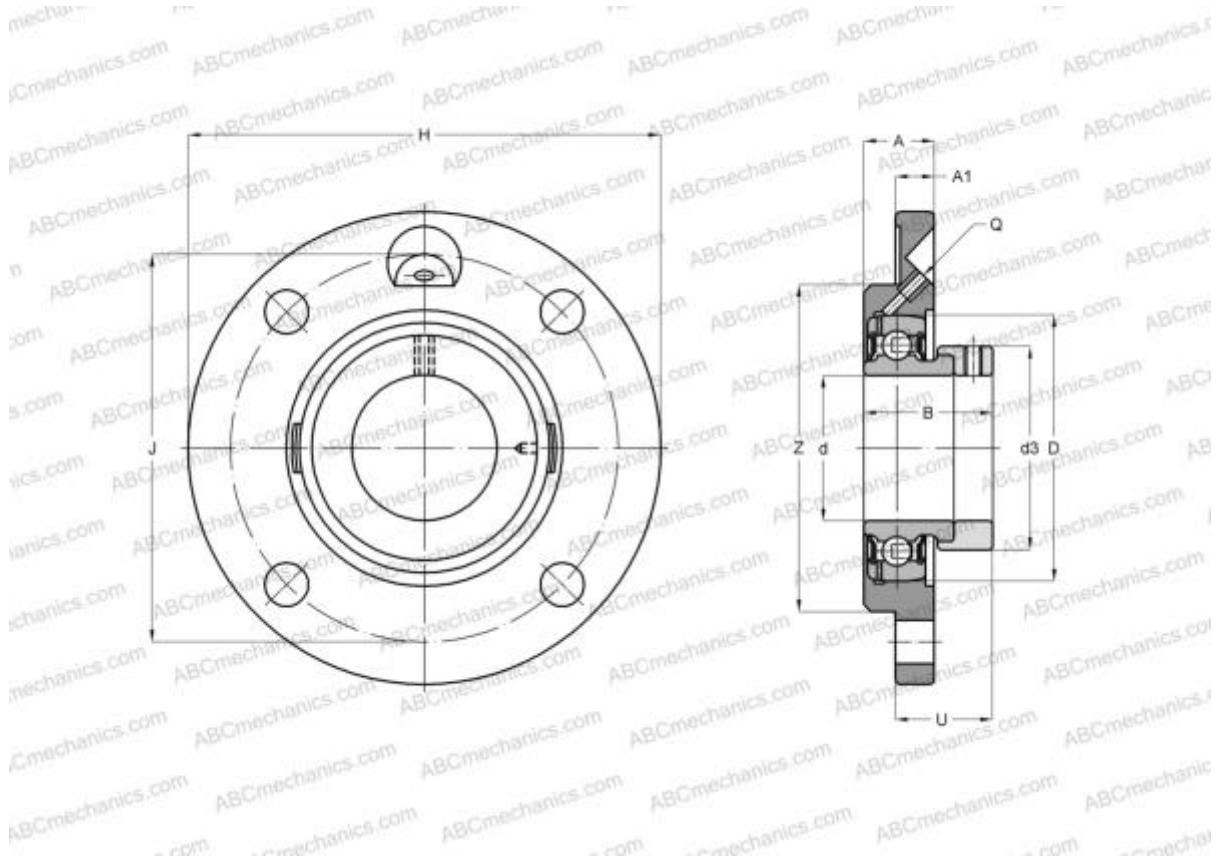

### Technical specification

#### DIMENSIONS, MM

d	17,000
D	40,000
B	28,600
H	100,000
A	18,000
J	78,000
A1	8,000
N	9,000
d3	28,600
U	20,100
Z	62,000
Q	M6x1

**WEIGHT, KG** 0,500

Bearing	ES203
Housing	FCE203

**MANUFACTURER** [SNR](#)

**INTERCHANGE** [ABC](#) [ESFCE203](#)

#### CALCULATION DATA

Basic dynamic load rating, C	9,550 kN
Basic static load rating, Co	4,780 kN
Operating temperature min	-20 °C
Operating temperature max	110 °C