

PME20-N INA

Ball bearing units

TYPE: Housing units, Four-bolt flanged housing units, Cast iron housing, Radial insert ball bearing with eccentric locking collar, With inner ring extended at one side, round flanged

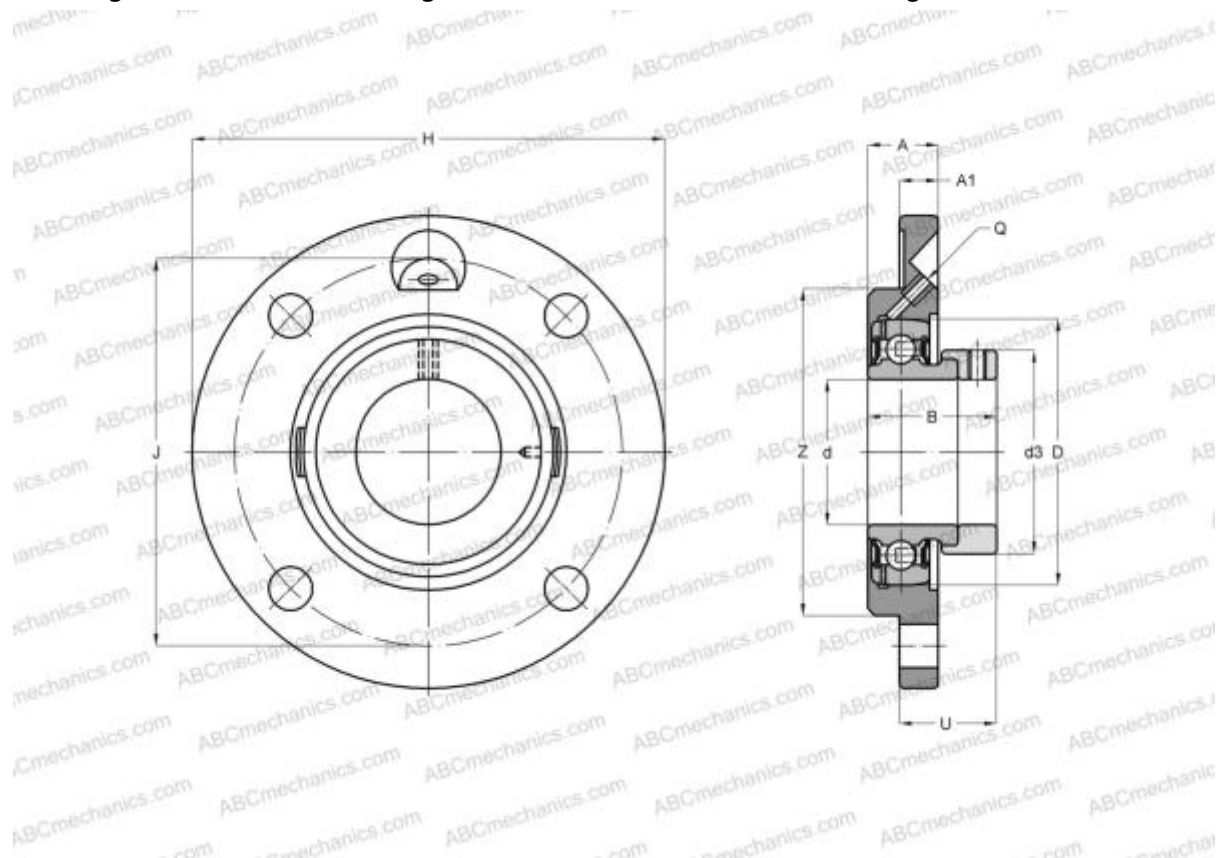

Technical specification

DIMENSIONS, MM

d	20,000
D	47,000
B	31,000
H	100,000
A	17,000
J	78,000
A1	8,000
N	9,000
d3	33,000
U	21,500
Z	62,000
Q	M6

WEIGHT, KG 0,530

Bearing	GRAE20-NPP-B
Housing	GG.ME04-N
Protective cover	KASK04

MANUFACTURER

[INA](#)

INTERCHANGE

ABC	ESFCE204
SNR	ESFCE204
SLB	SAFC 204

CALCULATION DATA

Basic dynamic load rating, C	12,800 kN
Basic static load rating, Co	6,600 kN