

ESFCE204 SNR

Ball bearing units

TYPE: Housing units, Four-bolt flanged housing units, Cast iron housing, Radial insert ball bearing with eccentric locking collar, With inner ring extended at one side, round flanged

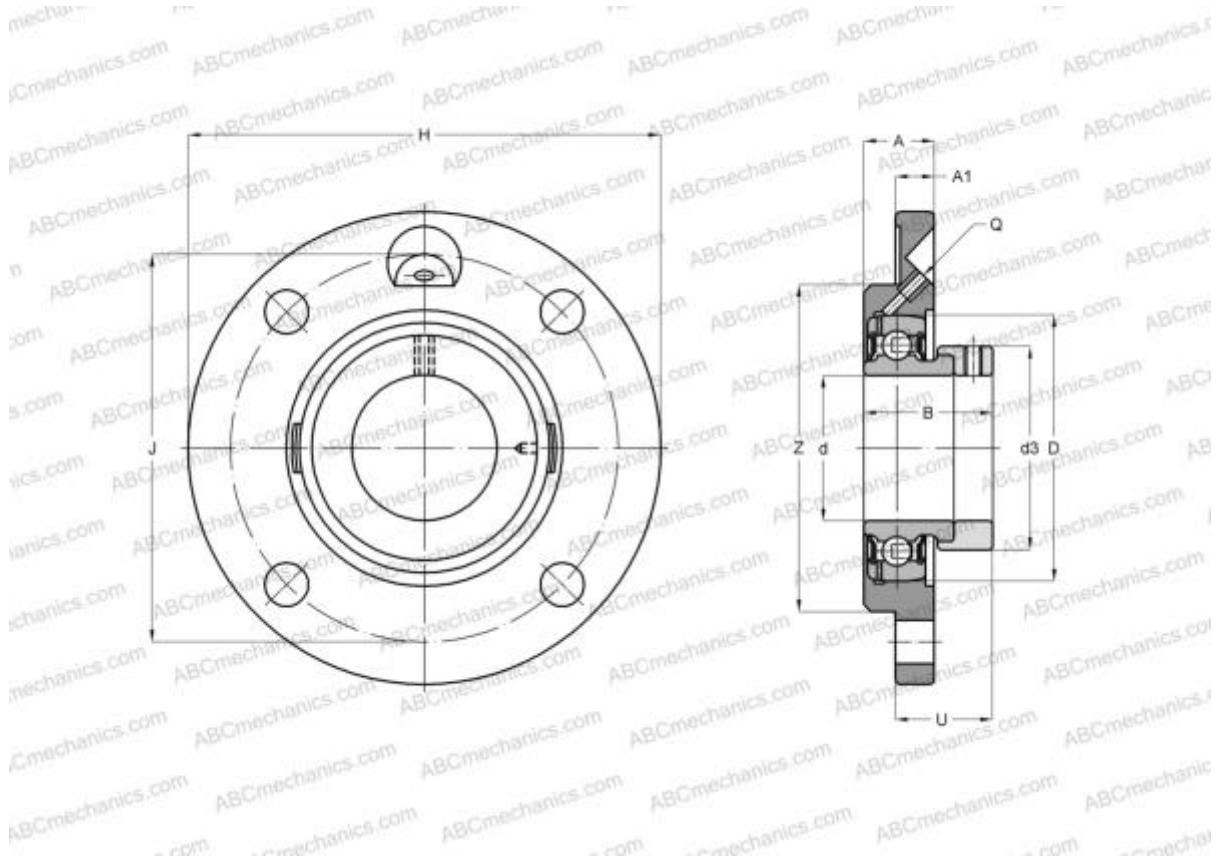

Technical specification

DIMENSIONS, MM

d	20,000
D	47,000
B	30,900
H	100,000
A	18,000
J	78,000
A1	8,000
N	9,000
d3	33,300
U	21,400
Z	62,000
Q	M6x1

WEIGHT, KG 0,500

Bearing	ES204
Housing	FCE204

MANUFACTURER

[SNR](#)

INTERCHANGE

ABC	ESFCE204
INA	PME20-N
SLB	SAFC 204

CALCULATION DATA

Basic dynamic load rating, C	12,800 kN
Basic static load rating, Co	6,650 kN
Operating temperature min	-20 °C
Operating temperature max	110 °C