

EXFCE205 ABC

Ball bearing units

TYPE: Housing units, Four-bolt flanged housing units, Cast iron housing, Radial insert ball bearing with eccentric locking collar, With inner ring extended on both sides, round flanged

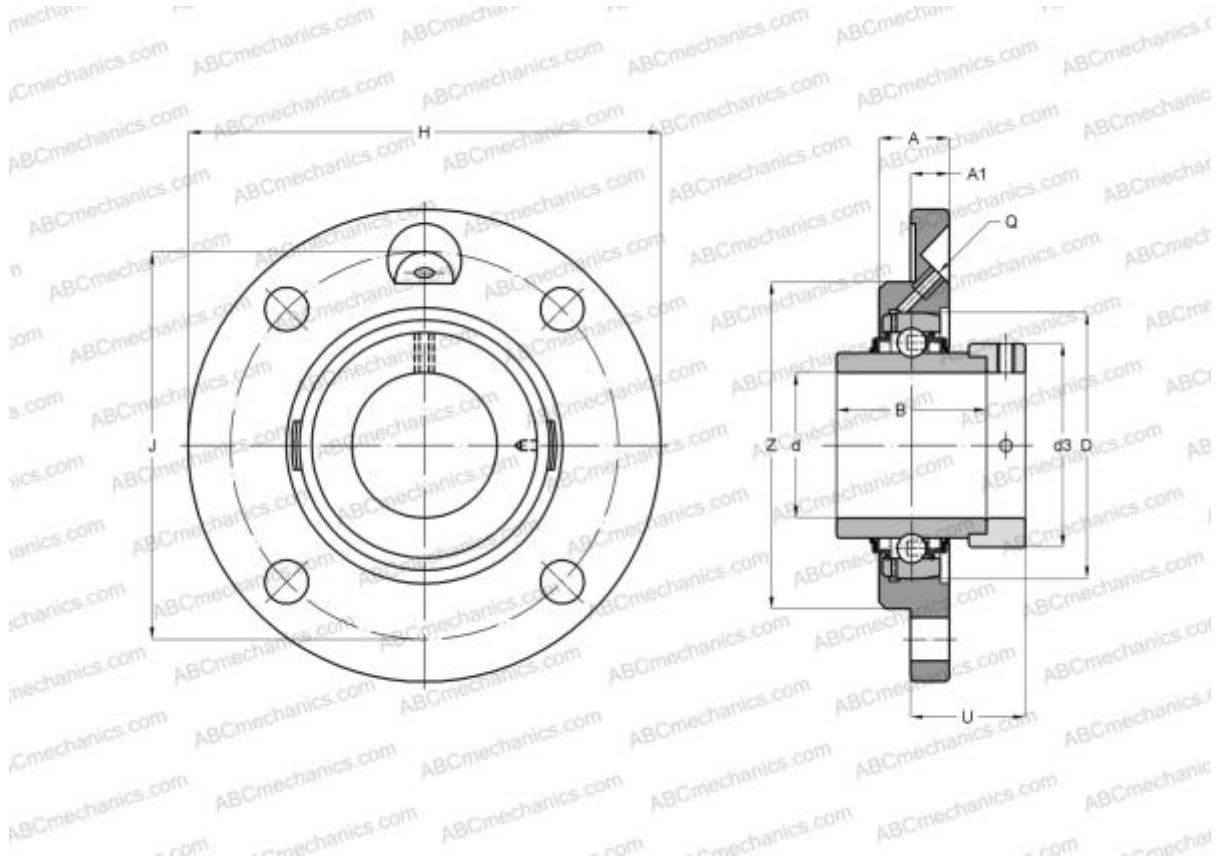

Technical specification

DIMENSIONS, MM

d	25,000
D	52,000
B	44,300
H	115,000
A	20,000
J	90,000
A1	9,000
N	9,000
d3	38,100
U	24,400
Z	70,000
Q	M6x1

WEIGHT, KG 0,800

Bearing	EX205
Housing	FCE205

MANUFACTURER

[ABC](#)

INTERCHANGE

INA	RME25-N
SNR	EXFCE205