

USFCE201 ABC

Ball bearing units

TYPE: Housing units, Four-bolt flanged housing units, Cast iron housing, Radial insert ball bearing with grub screws in inner ring, With inner ring extended at one side, round flanged

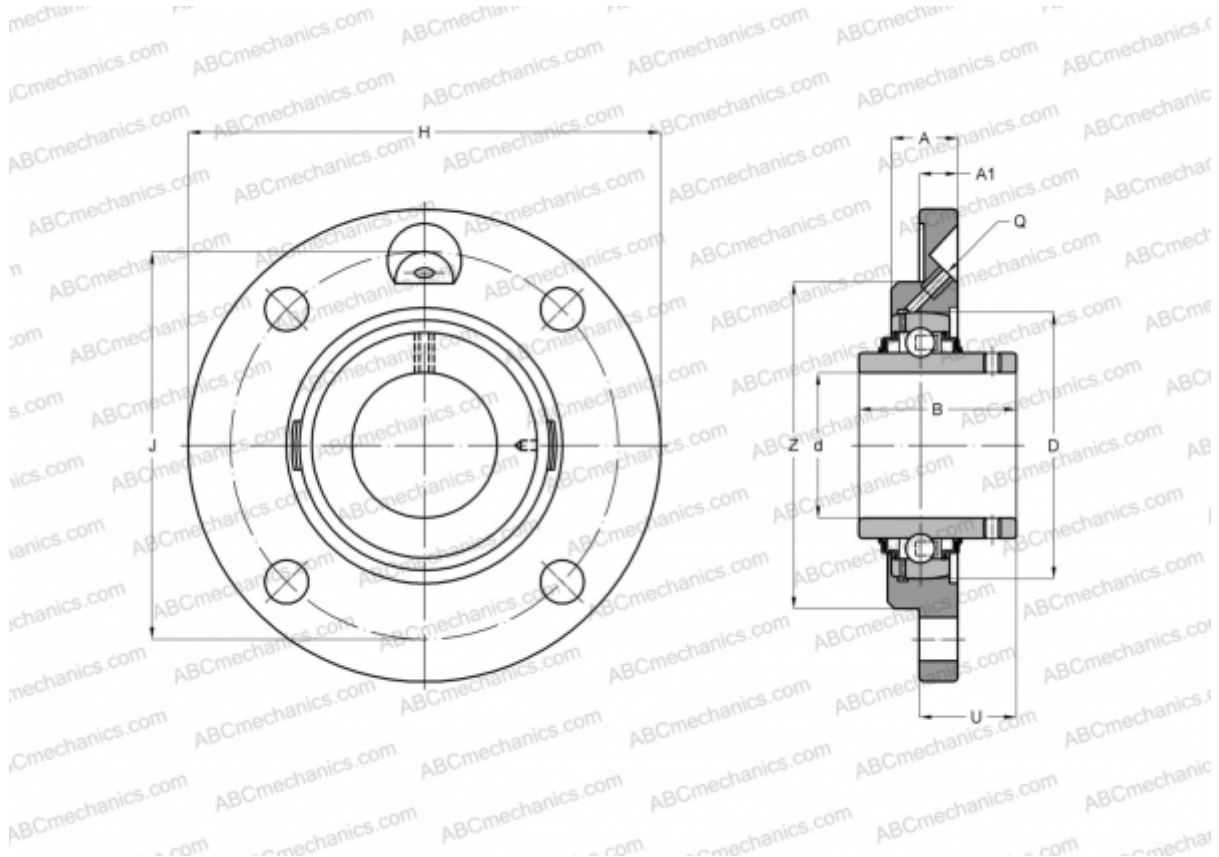

Technical specification

DIMENSIONS, MM

d	12,000
D	40,000
B	22,000
H	100,000
A	18,000
J	78,000
A1	8,000
N	9,000
U	14,000
Z	62,000
Q	M6x1

WEIGHT, KG 0,500

Bearing US201

Housing

FCE203

MANUFACTURER

[ABC](#)

INTERCHANGE

SNR

[USFCE201](#)