

USFCE205 SNR

Ball bearing units

TYPE: Housing units, Four-bolt flanged housing units, Cast iron housing, Radial insert ball bearing with grub screws in inner ring, With inner ring extended at one side, round flanged

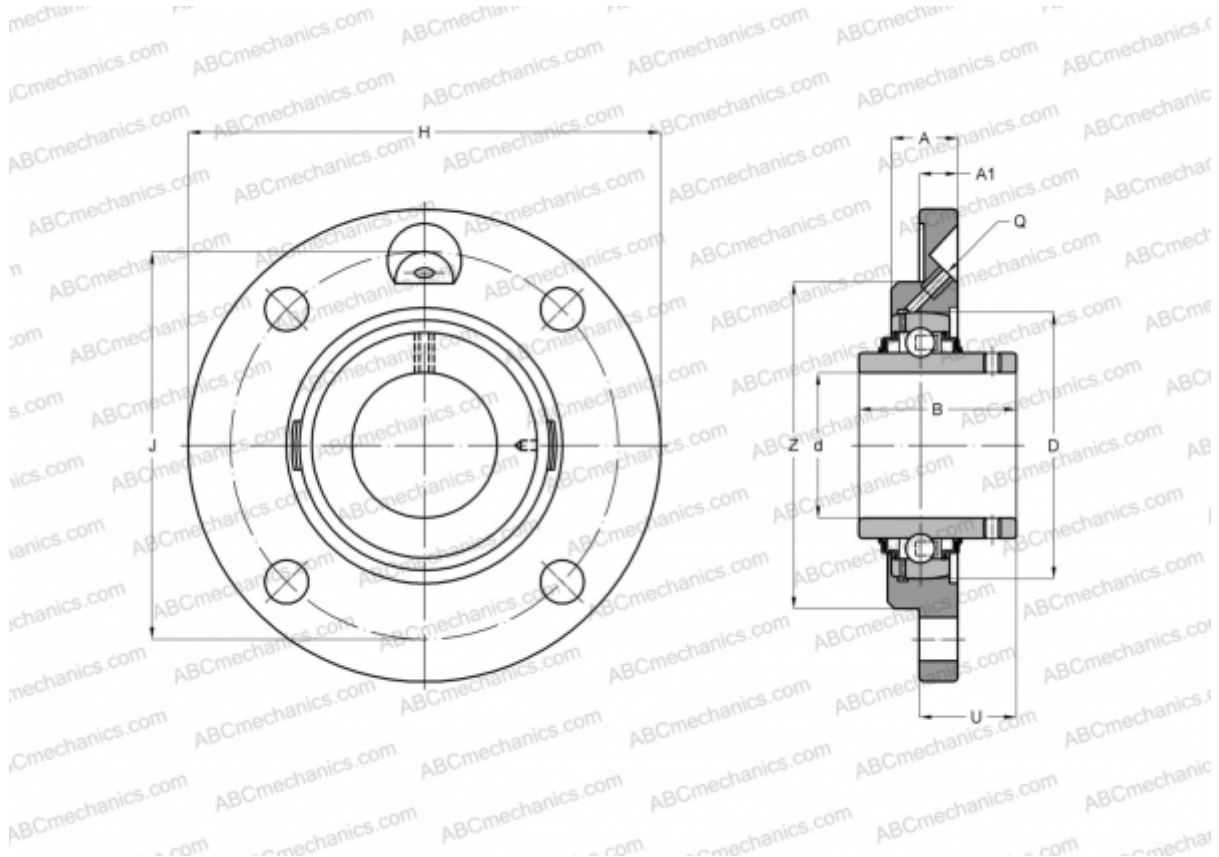

Technical specification

DIMENSIONS, MM

d	25,000
D	52,000
B	27,000
H	115,000
A	20,000
J	90,000
A1	9,000
N	9,000
U	17,000
Z	70,000
Q	M6x1

WEIGHT, KG 0,800

Bearing US205

Housing FCE205

MANUFACTURER [SNR](#)

INTERCHANGE

ABC [USFCE205](#)

INA [PMEY25-N](#)

CALCULATION DATA

Basic dynamic load rating, C 14,000 kN

Basic static load rating, Co 7,880 kN

Operating temperature min -20 °C

Operating temperature max 110 °C