

UCFCE201 SNR

Ball bearing units

TYPE: Housing units, Four-bolt flanged housing units, Cast iron housing, Radial insert ball bearing with grub screws in inner ring, With inner ring extended on both sides, round flanged

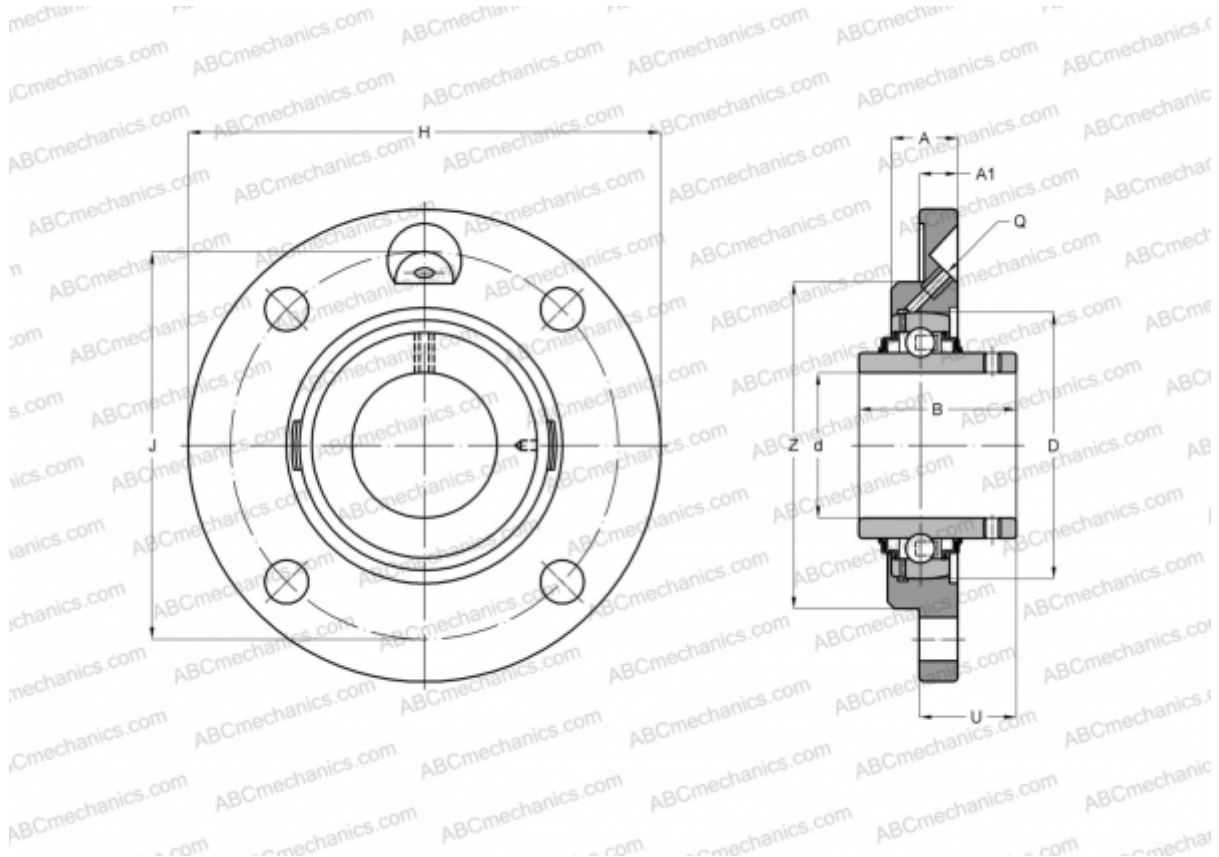

Technical specification

DIMENSIONS, MM

d	12,000
D	47,000
B	31,000
H	100,000
A	18,000
J	78,000
A1	8,000
N	9,000
U	16,300
Z	62,000
Q	M6x1

WEIGHT, KG 0,600

Bearing UC201

Housing FCE204

MANUFACTURER [SNR](#)

INTERCHANGE

ABC [UCFCE201](#)

CALCULATION DATA

Basic dynamic load rating, C	12,800 kN
Basic static load rating, Co	6,650 kN
Operating temperature min	-20 °C
Operating temperature max	110 °C